



©2014 Welch Allyn, Inc.  
MM 721358 Ver. C

# Standard laryngoscope blade assemblies

## Directions for use

---

### Intended use

The rigid laryngoscope is a device used to examine and visualize a patient's airway and aid placement of a tracheal tube.

### About this document

This directions for use applies to Welch Allyn reusable standard laryngoscope blade assemblies MacIntosh REF: 6904X, English MacIntosh REF: 6924X, and Miller REF: 6804X and REF 68470. Welch Allyn reusable standard laryngoscope blade assemblies may be used with Welch Allyn standard laryngoscope handles 60200, 60300, 60400, 60305, and 60710.

### Warnings and cautions



**WARNING:** Reusable fiber optic laryngoscope blade assemblies must be reprocessed after each use.



**WARNING:** The reprocessing procedure and the equipment and materials described must be followed and conducted by persons trained and familiar with medical device reprocessing.



**WARNING:** Consult cleaning and disinfecting agent manufacturer instructions for their proper preparation and use.



**WARNING:** Repeated reprocessing may degrade elements of the device. Follow inspection procedures to assure damage has not occurred to the blade assembly.



**WARNING:** Only trained personnel shall use a laryngoscope for intubation.



**WARNING:** Do not reprocess laryngoscope blade assemblies used on patients with Creutzfeldt-Jakob disease. These instruments should be discarded.



**WARNING:** Discard any component that shows evidence of damage or deterioration.



**WARNING:** Do not modify this equipment. Any modification of this equipment can lead to patient injury. Any modification of this equipment voids the product warranty.



**WARNING:** Personnel shall follow their facility policies and procedures and wear appropriate personal protective equipment when handling potentially contaminated equipment.



**WARNING:** Laryngoscope equipment is not suitable for use in intense magnetic fields.



**WARNING:** Lamps if left illuminated, could generate sufficient heat to cause burns.



**CAUTION:** Only use lamps specified. Failure to follow these instructions may cause damage or poor performance of this device.



**CAUTION:** Only use neutral pH (6.0-8.0) enzymatic type cleaners.



**CAUTION:** Only use neutral pH (6.0-8.0) ortho-phthalaldehyde (OPA) or glutaraldehyde disinfectants.



**CAUTION:** Do not use other cleaners or disinfectants.



**CAUTION:** Do not remove lamp during reprocessing. Damage to device could occur.



**CAUTION:** REF 68470 is not compatible with any sterilization process.

## Reprocessing instructions

*Reprocessing* refers to procedures for cleaning and disinfection or sterilization of devices. The standard laryngoscope blade assemblies must be reprocessed prior to first use and between each use using any of the following methods outlined in this document:

- Cleaning and cold solution high level disinfection
- Cleaning and gravity autoclave sterilization
- Cleaning and pre-vacuum autoclave sterilization
- Cleaning and Steris® Amsco® V-PRO® low temperature sterilization
- Cleaning and STERRAD® hydrogen peroxide gas plasma sterilization

Welch Allyn has validated these instructions as being capable of preparing its laryngoscope blade for re-use. The user must ensure that the reprocessing as actually performed by the user's personnel, with the user's equipment and materials, achieves the desired result. This may require validation and routine monitoring of the user's actual process.

## Cleaning instructions



**CAUTION:** Do not remove lamp during reprocessing. Damage to device could occur.

Point of use:	<ol style="list-style-type: none"> <li>1. Separate blade assembly from handle and place the blade assembly into suitable containment for subsequent reprocessing. See Figure 1. Do not place the blade assembly with sharp devices.</li> <li>2. Prevent the blade assembly from drying per facility practice (for example, use immersion, neutral pH enzymatic pre-cleaner or foam, or cover with a moist towel).</li> </ol>
Preparation for decontamination:	<ol style="list-style-type: none"> <li>1. Disassemble the blade assembly per Figure 2.</li> <li>2. Keep all blade components together to prevent loss.</li> <li>3. Select a neutral pH enzymatic cleaner.</li> <li>4. Prepare cleaning solution per cleaning solution manufacturer instructions.</li> </ol>

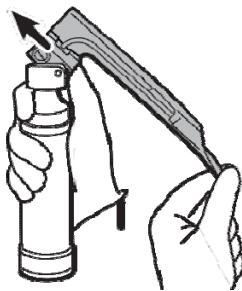

Figure 1

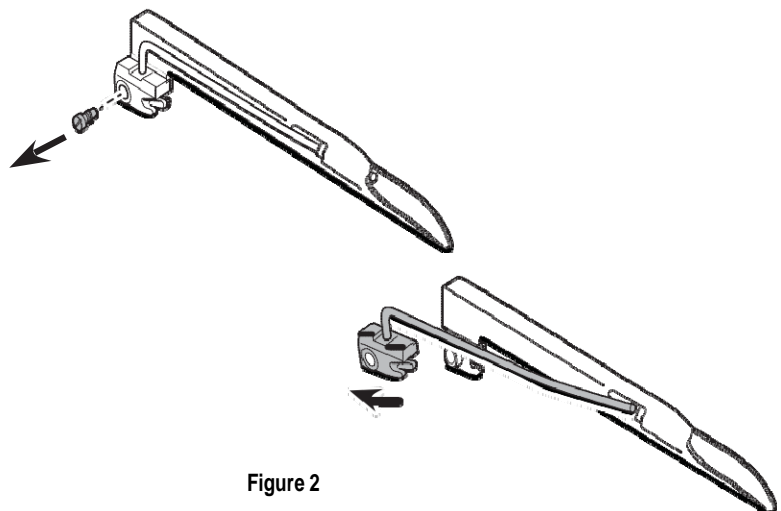

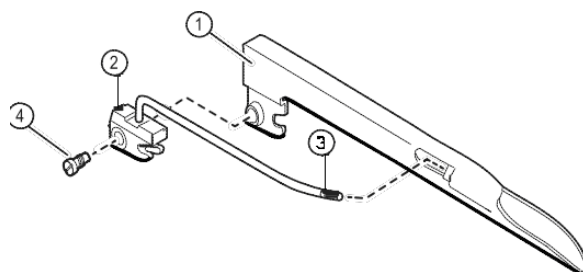

Figure 2

<p>Manual cleaning process:</p>	<ol style="list-style-type: none"> <li>1. Immerse all components in a neutral pH enzymatic cleaning solution as directed by solution manufacturer's instructions.</li> <li>2. While components are immersed in the cleaning solution, use a soft-bristled brush to clean all component surfaces (the blade, retaining screw, and light carrier) until all visible contamination is removed.</li> <li>3. Thoroughly rinse all components in one of the following: potable filtered water, softened water, or per cleaning solution manufacturer instructions, or per facility instructions to remove cleaning solution.</li> </ol>
<p>Drying:</p>	<p>After cleaning, dry all components with a clean cloth or allow to air dry.</p>
<p>Maintenance, Inspection and Testing prior to disinfection or sterilization:</p>	<ol style="list-style-type: none"> <li>1. Inspect each component area (per Figure 3) for damage or deterioration. Also, inspect the following areas for deterioration: <ul style="list-style-type: none"> <li>• hooks of laryngoscope blade (1) and light assembly (2)</li> <li>• lamp (3)</li> <li>• threads of blade (1) and locking screw (4)</li> </ul> <p> <b>WARNING:</b> Discard any component that shows evidence of damage or deterioration.</p> <p>Contact Welch Allyn for component replacement.</p> </li> <li>2. Reassemble the blade assembly by reversing steps illustrated in Figure 2.</li> <li>3. Attach blade assembly to a clean and disinfected test handle in known working condition. Verify that: <ul style="list-style-type: none"> <li>• Blade assembly engages and locks onto handle.</li> <li>• Blade assembly deploys into its locked position on handle AND lamp illuminates.</li> <li>• Verify that light output is satisfactory.</li> </ul> <p>If the lamp fails to light or output is low, check or replace the lamp.</p> </li> </ol>

**After cleaning; choose either cold solution high level disinfection method (page 4) for any blade or one of the four sterilization methods (page 4-5) except REF 68470**

Figure 3



- 1. Laryngoscope blade
- 2. Light assembly
- 3. Lamp
- 4. Locking screw

## Cold solution high level disinfection instructions

Preparation for decontamination:	<ol style="list-style-type: none"> <li>1. Select a neutral pH ortho-phthalaldehyde (OPA) or glutaraldehyde disinfectant.</li> <li>2. Prepare disinfecting solutions per disinfectant solution manufacturer instructions.</li> </ol>
Cold solution high level disinfection:	<ol style="list-style-type: none"> <li>1. Disassemble the blade per Figure 2.</li> <li>2. Immerse all components in disinfectant solution for the time duration specified by the disinfectant manufacturer to achieve high level disinfection.</li> <li>3. Thoroughly rinse all components in one of the following: potable water, softened water, deionized water, or high purity water (for example, RO or distilled water) or per disinfectant solution manufacturer instructions, or per facility instructions to thoroughly remove disinfection solution.</li> </ol>
Drying:	After cleaning, dry all components with a clean cloth or allow to air dry.
Assembly:	Reassemble the blade assembly by reversing steps illustrated in Figure 2.
Packaging:	Package the clean and disinfected blade assembly per facility practice for return to service.
Storage:	Store packaged blade assembly per facility practice to allow device to remain clean, dry, and ready for service.
<b>End of reprocessing instructions for cold solution high level disinfection.</b>	

## Sterilization instructions



CAUTION: REF 68470 is not compatible with any sterilization process.

**After maintenance, inspection and testing, select one of the following four packaging, sterilization, and storage methods:**

### Gravity autoclave sterilization

Packaging: Package the blade assembly in an appropriately sized single pouch or in a wrap labeled as appropriate for the steam autoclave exposure parameters outlined below; package the blade assembly per facility practice in preparation for autoclave.

Gravity autoclave sterilization: Follow equipment manufacturer and facility procedures in the set-up and operation of autoclave equipment. Gravity autoclave settings are as follows:

- Temperature: 132 C (270 F)
- Exposure time: 15 minutes (wrapped)
- Minimum dry time: 30 minutes

Storage: Store per facility practice to allow the packaged blade assembly to remain clean, dry and ready for service.

---

**Pre-vacuum autoclave sterilization**

Packaging: Package the blade assembly in an appropriately sized single pouch or in a wrap labeled as appropriate for the pre-vacuum autoclave exposure parameters outlined below; package the blade assembly per facility practice in preparation for autoclave.

Pre-vacuum autoclave sterilization: Follow equipment manufacturer and facility procedures in the set-up and operation of autoclave equipment. Pre-vacuum autoclave settings are as follows:

- Temperature: 132 C (270 F)
- Exposure time: 4 minutes (wrapped)
- Minimum dry time: 20 minutes

Storage: Store per facility practice to allow the packaged blade assembly to remain clean, dry and ready for service.

---

**Steris® Amsco® V-PRO® low temperature sterilization**

Packaging: Package the blade assembly per facility practice in an appropriately sized single pouch or in a wrap labeled as appropriate for the Steris® Amsco® V-PRO® collection of low temperature sterilization equipment and exposure parameters.

Steris® Amsco® V-PRO® low temperature sterilization: Follow equipment manufacturer and facility procedures in the set-up and operation of Steris® Amsco® V-PRO® low temperature sterilization equipment. V-PRO® sterilization settings are as follows:

- V-PRO 1: Lumen cycle
- V-PRO 1 PLUS: Lumen cycle, non-Lumen cycle
- V-PRO maX: Lumen cycle, non-Lumen cycle, Flexible cycle

Storage: Store per facility practice to allow the packaged blade assembly to remain clean, dry and ready for service.

---

**STERRAD® hydrogen peroxide gas plasma sterilization**

Packaging: Package the blade assembly per facility practice in an appropriately sized single pouch, tray or in a container labeled as appropriate for the STERRAD® hydrogen peroxide gas plasma exposure parameters.

STERRAD® hydrogen peroxide gas plasma sterilization: Follow equipment manufacturer and facility procedures in the set-up and operation of the STERRAD® hydrogen peroxide gas plasma sterilization equipment. STERRAD® hydrogen peroxide gas plasma sterilization systems and cycles are as follows:

- STERRAD 100S: Standard (short) cycle
- STERRAD 100S: Long cycle (outside of US only)
- STERRAD NX: Standard, Advanced cycles
- STERRAD 100NX: Express, Standard cycles

Storage: Store per facility practice to allow the packaged blade assembly to remain clean, dry and ready for service.

---

**End of reprocessing instructions for sterilization.**

---

## Maintenance instructions

Replace the lamp and/or light assembly (REF: 6904X, 6924X, and 6804X)



**CAUTION:** Use only lamps specified to ensure proper performance.

Use lamp REF 04700 for: 69041, 2, 69241, 2, 68045, 0, 1, and 68470 blade/light assemblies  
Use lamp REF 04800 for: 69043, 4, 69243, 4, and 68042, 3, 4 blade/light assemblies

1. Remove the locking screw by rotating counterclockwise with a standard screwdriver.
2. Pull light assembly away from base of laryngoscope blade and slide distal end out of blade.
3. To replace lamp: Rotate lamp counterclockwise until free and insert a new lamp and tighten.
4. Position new or re-lamped light assembly the reverse order of step 2.
5. Replace locking screw and rotate clockwise until secure.
6. Verify lamp and blade engagement/operation using a known working test handle.
7. Reprocess repaired assembly as appropriate per these instructions.

Figure 2

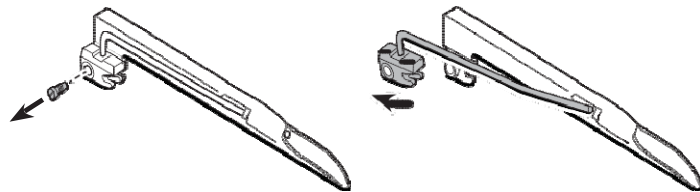

## Specifications

### Electrical:

For use with ISO 7376-1 (black code) standard type handles only

For information about electromagnetic compatibility (EMC) see Welch Allyn website:  
<http://www.welchallyn.com>

### Operating:

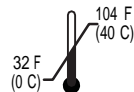

### Storage/Transport:

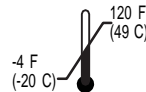

### Approvals:

Conforms to ASTM F 965 and ISO-7376-1, IEC/EN 60601-1, IEC/EN 60601-1-2



The CE mark on this product indicates that it has been tested to and conforms with the provisions noted within the 93/42/EEC Medical Device Directive.



Complies with EMC Framework of Australia

**Warranty:** One year

### Service Information:

For Technical Support or to obtain information about any Welch Allyn product, contact Welch Allyn Technical Support: [www.welchallyn.com/support](http://www.welchallyn.com/support).



Welch Allyn, Inc.  
4341 State Street Road  
Skaneateles Falls, NY 13153-0220 USA  
[www.welchallyn.com](http://www.welchallyn.com)



Authorized European Representative Address:  
Regulatory Affairs Representative  
Welch Allyn, Limited  
Navan Business Park  
Dublin Road  
Navan, County Meath, Republic of Ireland