



Service Manual

# Exam Light III Examination Light

488061 Rev. B

Welch Allyn Medical Division  
4341 State Street Road  
P.O. Box 220  
Skaneateles Falls, NY 13153-0220  
Copyright 2002



---

<b>Part#</b>	<b>Revision</b>	<b>Description</b>	<b>ECN#</b>	<b>Date</b>	<b>Approved</b>
488061	A	New service manual	5-45435	01/20/03	DK
488061	B	Page 24, Bubble 81, 488119 changed to new 714160	D*	08/12/09	D*

D\*: See SAP DIR for change number, approver name, and date of approval.

Drawings and/or illustrations and/or part numbers contained in this document are for reference purposes only. For current revisions call the Welch Allyn Customer Service phone number listed in Section 1 page 3.

---

# Table Of Contents

## Section 1: General Information

About the Exam Light.....	1
Features .....	1
Agency Approvals .....	1
Cautions and Warnings.....	2
Help Information .....	3

## Section 2: Incoming Inspection

Incoming Inspection.....	1
Required Tools.....	1

## Section 3: Troubleshooting

Initial Screening.....	1
Light Pipe.....	1
Focusing Sleeve .....	1
Electrical Troubleshooting .....	1

## Section 4: Disassembly and Repair

Cover Removal.....	1
EMI Shield Removal.....	1
Lamp Clip Removal .....	1
Lamp Removal .....	2
Lamp Holder Removal.....	2
Lamp Baffle Removal.....	2
Light Pipe Connector Assembly Removal .....	3
Transformer Removal .....	3
Illuminated On/Off Switch Removal.....	4
Fan Removal .....	4
Rectifier Board Removal.....	5
Light Pipe Connector Assembly Disassembly.....	6
Focusing Sleeve Assembly.....	8

Appendix A: Repair Part Numbers

Appendix B: Exploded View Drawings/Photos

Appendix C: Electrical Schematic





## About the Exam Light III

Welch Allyn's Exam Light III™ takes flexible illumination to a new level. It mounts easily to fit on a wall, stand, or on an examination table. The Exam Light III delivers bright, white, fiber optic illumination for better visibility and more accurate diagnosis.

### Features

- Durable fiber optic pipe provides cool illumination and is bendable to almost any position.
- Easy to position, small, non-obstrusive head does not block view for task areas.
- Light weight focusing sleeve optics are sealed for less dust.
- Provides homogenous spot and variable spot size.
- Easy to maintain dichronic halogen lamp provides brighter, whiter light (3,200°F).
- Multiple mounting options for greater flexibility.
- Special UV filters provide safe trans illumination of neonates to detect pneumothorax conditions and intracranial hemorrhaging, perform infant venipuncture, and locate blood vessels (Model 48760 only).

### Agency Approvals



ETL listed  
UL2601-1,  
CSA C22.2 No. 601.1  
IEC 60601-1, AS 3200.1  
IEC 60601-1-2



The CE mark on this product indicates that it has been tested to and conforms with the provisions noted within the 89/336/ECC Electromagnetic Compatibility Directive.



Australia EMC Framework Compliance

## Cautions and Warnings

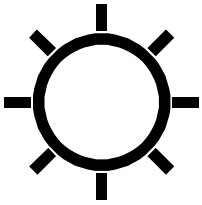

Intense Light: Lamp is extremely bright. Do not stare at the lamp when in use. May be harmful to eyes.



Caution: Remove power cord from electrical outlet and allow lamp to cool 10 minutes before replacing with a Welch Allyn lamp.

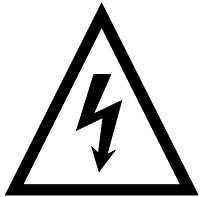

Danger: Electrical shock hazard. Refer servicing to qualified service personnel.



Caution: Risk of explosion if used in the presence of flammable anesthetics.

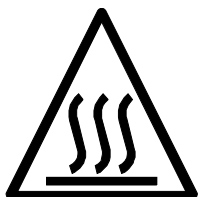

Hot Surface: Lamp is hot. May be harmful to skin if touched.

NOTE: This product complies with the current required standards for electromagnetic interference and should not interfere with other equipment or be affected by other compliant devices. As a precaution, avoid using this device in close proximity to other equipment.



## Help Information

To assure correct operation and performance all service and repairs must be performed by fully trained and properly equipped personnel, using genuine replacement parts and correct procedures. Failure to do so will also invalidate the product warranty.

**Welch Allyn Inc.**

State Street Plant /Corporate Headquarters  
4341 State Street Road  
Skaneateles Falls, NY 13153-0220, USA

tel: 1-800-535-6663  
315-685-4100  
fax: 315-685-3361  
[www.welchallyn.com/medical/support/tech](http://www.welchallyn.com/medical/support/tech)

**Welch Allyn GMBH**

Zollerstrasse 2-4  
72417 Jungingen, Germany

tel: (011) 49-7477-927186  
fax: (011) 49-7477-927193

**Welch Allyn UK Ltd**

St. Georges House  
Vernon Gate, Derby  
England DE1 1UQ

tel: (011) 44-01332-206208  
fax: (011) 44-01332-206209  
mob: (011) 44-0467-301814

**Welch Allyn Singapore Ltd**

300 Beach Road, #25-08  
The Concourse  
Singapore 199589, Singapore

tel: (011) 65-291-0882  
fax: (011) 65-291-5780

**Welch Allyn Japan K.K.**

Bon Marusan 8F, 3-5-1 Kanda  
Jinbo-Cho, Chiyoda-Ku  
Tokyo 101-0051  
Japan

tel: (011) 813-5212-7391  
fax: (011) 813-3261-7372

**MD International**

11300 N.W. 41st Street  
Miami, FL 33178 USA

tel: 305-669-9003  
fax: 305-669-1971

**Welch Allyn France SARL**

814 rue Charles de Gaulle  
77100 Mareuil les Meaux  
France

tel: (011) 33 1.6009.3366  
Fax: (011) 33 1 .6009.6797

**Welch Allyn Australia Pty**

The Metro Centre Unit 5  
38-46 South Street  
Rydalmere NSW 2116, Australia  
Postal address:  
PO Box 132  
Rydalmere NSW 1701, Australia

tel: (011) 612 9638-3000  
fax: (011) 612 9638-3500

**China Service Center**

Room 708 Central Plaza  
No. 277 Huang Pi Bei Rd.  
Huang Pi District  
Shanghai 200003  
China

tel: (011) 86-21-63279631  
fax: (011) 86-21-63279632

Blank Page

## Incoming Inspection

*NOTE: Use the following guidelines when unpacking the Exam Light III from its shipping carton.*

1. Before opening the Exam Light shipping carton, check for damage.
2. If damage is apparent, stop unpacking the carton and contact the shipping company for further instructions. If the carton is intact, unpack the Exam Light.
3. With the Exam Light out of its carton, check to see that all the items listed on the packing slip are in the shipping carton.
4. If an item is missing, first check the carton, then check with your receiving department. If necessary contact Welch Allyn at the Address and phone number shown in Section 1.
5. Clean and disinfect by following the instructions printed in the Operator Manual.

*NOTE: Perform all functional tests before and after servicing.*

6. Operate the Exam Light to verify the customer complaint before making any changes to the unit. Call the customer if the complaint is unclear.
7. If the unit has caused or is suspected of having caused an injury of any type:  
**DO NOT DISASSEMBLE OR REPAIR THE UNIT IN ANY WAY.**  
Contact Welch Allyn Customer Service immediately.

## Required Tools

Phillips Screw Driver  
Flat Head Screw Driver  
Standard Needle Nose Pliers  
11/32 Nut Driver  
5/64 Nut Driver  
3/8 Nut Driver  
5/64 Hex wrench  
Digital MultiMeter

Blank Page

## Initial Screening

1. Inspect the Exam Light for physical damage - cracked cover, etc.
2. Attempt to confirm reason for return.
3. If reason can not be determined, contact the sender.

## Light Pipe

1. Flex the light pipe at each bend and replace any that:
  - A. Have noisy monocoils.
  - B. Show signs of not holding position.
  - C. Have excessive springback when positioned in a “U” position.

*NOTE: When the light pipe is placed in the “U” shape, at the center bend, the pipe should not spring back by more than 8 to 9 inches. When the light pipe is bent in a “U” shape at the light source bend, the spring back should not be more than 4 to 5 inches.*

## Focusing Sleeve

1. Check for cracks or damage.
2. Check for smooth operation of the lens when the sleeve is turned.
3. Replace any lens that have scratches.

## Electrical Troubleshooting



WARNING: Turn off and unplug unit between each of the next steps.

1. Lamp does not light and the green rocker switch does not light.
  - A. Pull fuses out and check fuses with ohm meter.
  - B. Attach a known good power cord.
  - C. Replace the green rocker switch.
  - D. Check the AC connector for damage and cracks.

2. Green rocker switch light is illuminated but the lamp does not light.

A. Check for proper lamp. It should be 12 volt 35 watt, Welch Allyn #04200.

*NOTE: If the lamp is replaced, burn the unit in for at least one hour to confirm there are not other issues.*

B. Check transformer output. It should measure 12vac.

C. Lift lamp out of bracket and check filter and gasket.

*NOTE: The gasket should not be blocking the light. The filter should not be cracked, chipped or dirty.*



Observe All ESD Precautions!

Turn unit off. Unplug the power cord from the outlet and from the light box!

1. Cover Removal

Unscrew the captured screw at the bottom of the main housing. Push the cover up and forward.

*NOTE: Take extreme care when removing the cover. The tabs on the cover may break if you do not push the cover all the way up before removal.*



2. EMI Shield Removal

Remove the 5 phillips head screws.

*NOTE: Notice manufactured date stamp on the EMI shield.*



3. Lamp Clip Removal

For first time lamp removal, grasp the wire clip at the top of the lamp. Rotate the clip toward the base of the unit it pops out.

*NOTE: Discard the clip. It is used only for shipping.*



#### 4. Lamp Removal

Grasp the lamp connector and pull the lamp straight out of its holder.



#### 5. Lamp Holder Removal

Remove the two nuts.

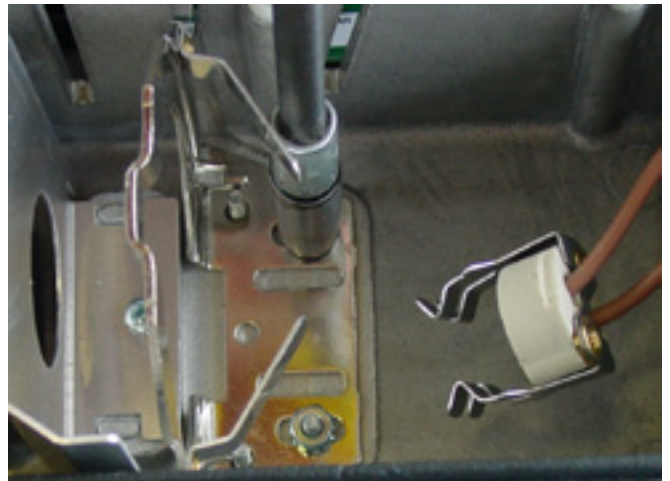

#### 6. Lamp Baffle Removal

Remove the one phillips head screw.

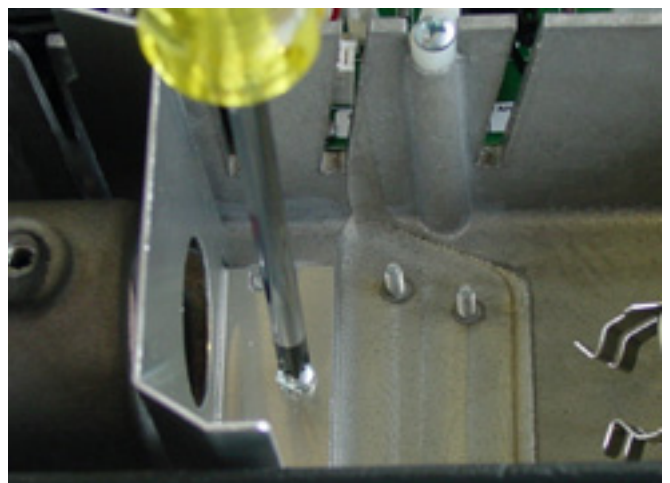



7. Light Pipe Connector Assembly Removal

With a 5/64 hex wrench, slightly back the hex nut off the pipe connector assembly. Slide the pipe connector assembly out. The pipe connector assembly can only be removed from the inside of the main housing

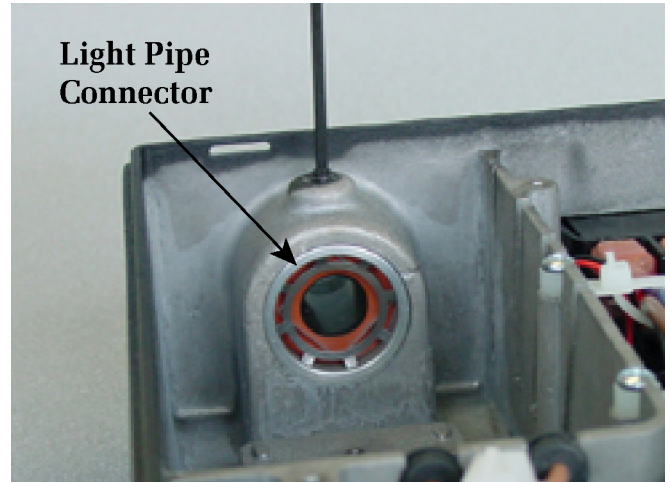

8. Transformer Removal

Remove the 4 phillips head screws.

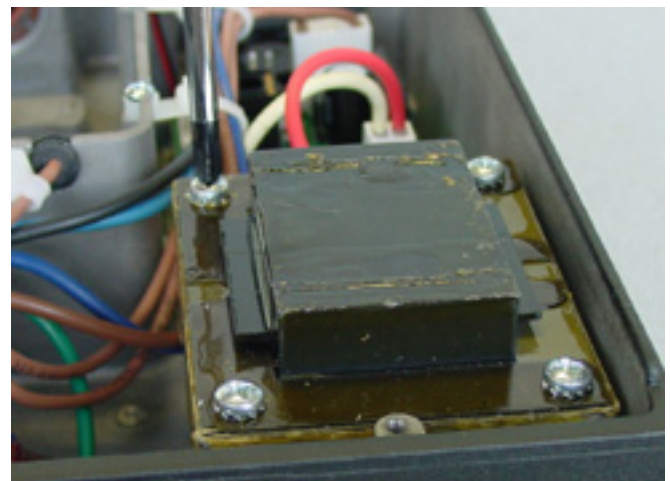

*NOTE: Note the wire orientation and wire color on the illuminated off/on switch. The wires must be removed from the illuminated switch before the illuminated switch can be removed.*

*The photo shows the wiring as wired for domestic 120V. See the wiring diagram in Appendix C for the wiring in your local area.*

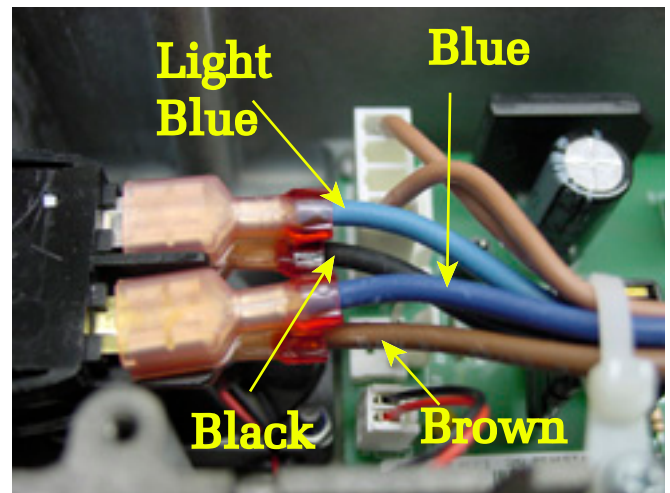

### 9. Illuminated Switch Removal

Squeeze the outer tabs on the switch and push outward.

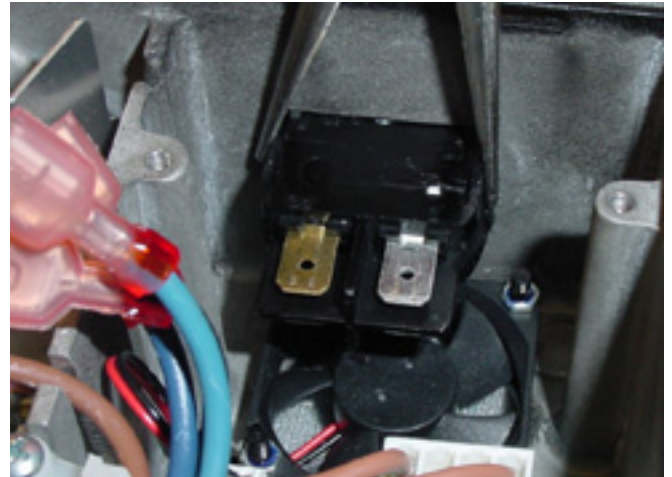

*NOTE: Notice the orientation of the switch when properly installed.*



### 10. Fan Removal

Use a 3/16 driver on the hex nut and a flat bed screw driver on the screw and remove all four fasteners. Disconnect the fan connector from the PCB.

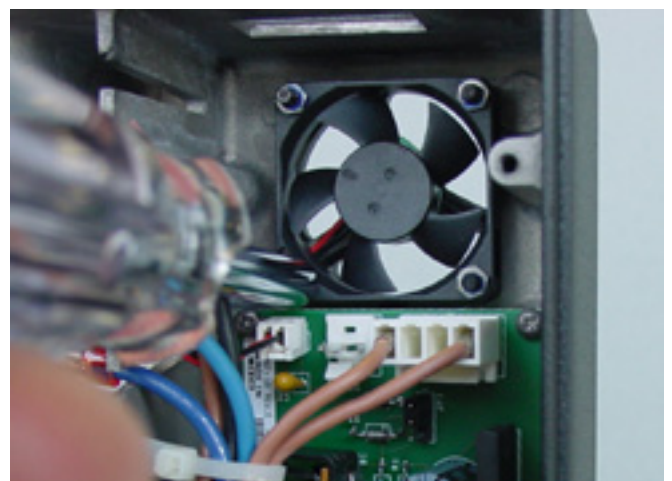

*NOTE:*

*A. Notice how the wires are secured to the chassis.*

*B. Notice how wires are routed through the channel with rubber grommets.*

*C. Notice wire ties on brown wires.*

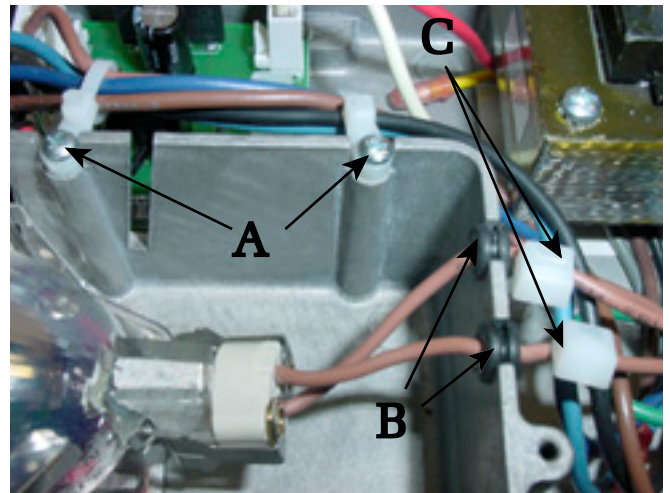

*Note: Notice the wiring orientation to the IEC connector and wire colors*

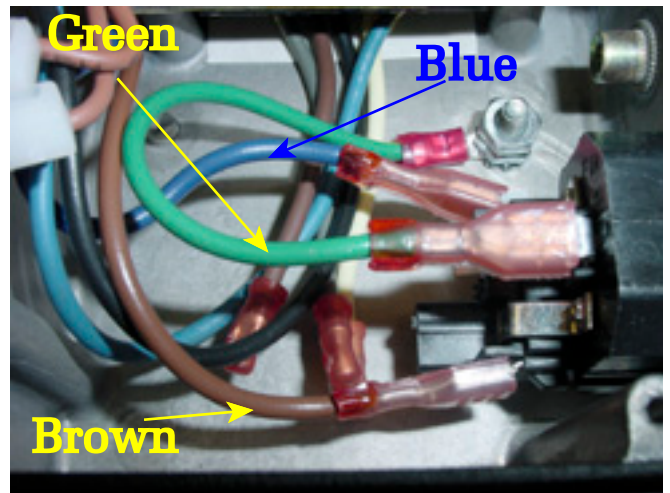

11. Rectifier board removal

Remove all four phillips head screws.





**12. Light Pipe Connector Assembly Disassembly.**

A. Remove the retaining ring.



B. Remove the square heat filter.

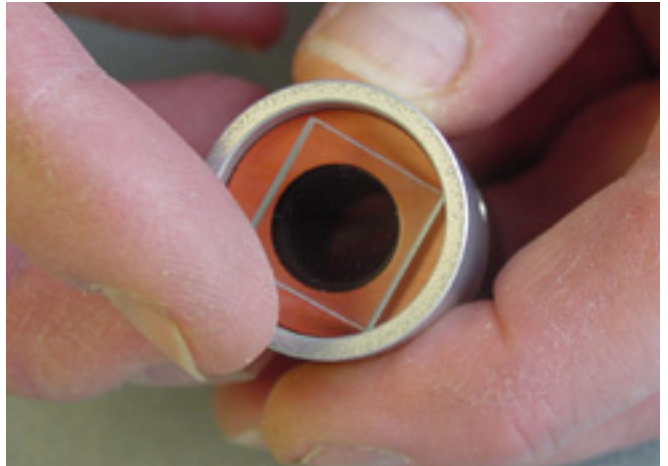

C. Remove the heat filter gasket.

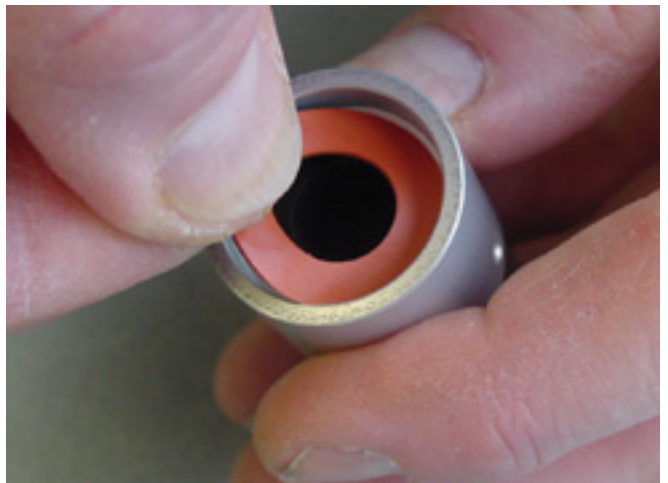

D. Remove the two hex set screws that secure the insulator to the retaining collar.

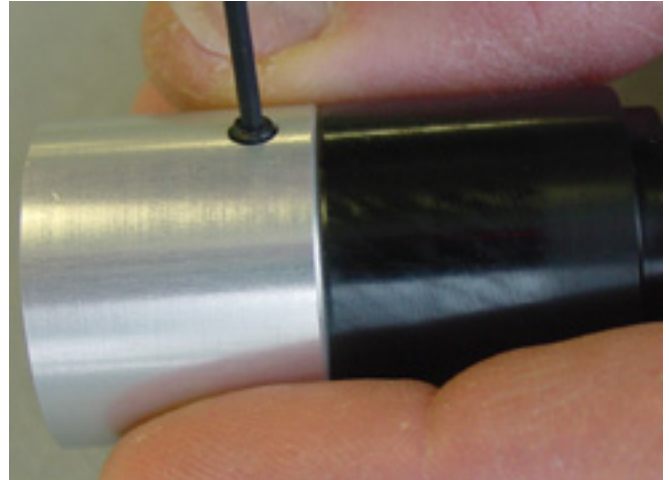

E. Pull the retaining collar from the insulator.

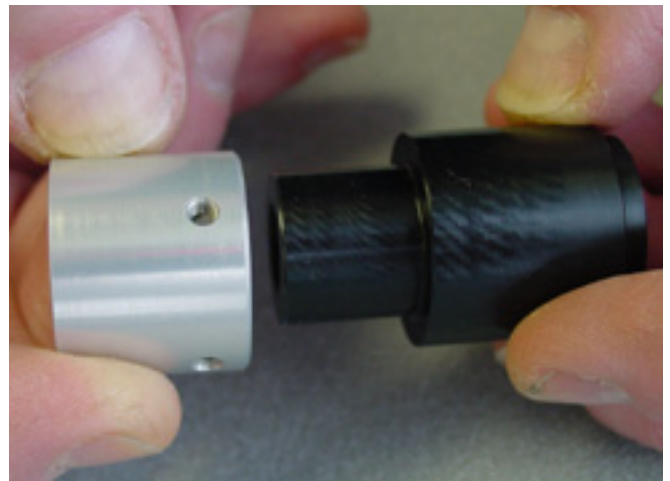

F. Remove the brake from the inside of the insulator.



### 13. Focusing Sleeve Assembly

A. Insert the rear lens inside the main body.

*NOTE: The rear lens is the lens with the smaller diameter convex shape in the middle of the lens. The convex shape should be facing outward.*

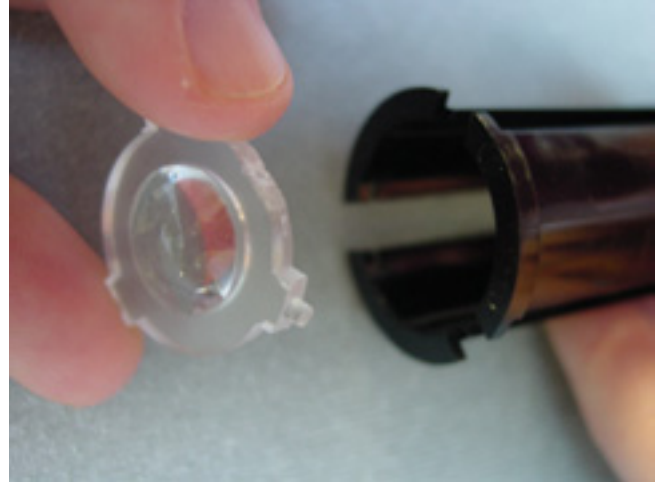

B. Insert the front lens into the main body.

*NOTE: The front lens is the lens with the larger convex shape. The convex shape should be facing outward.*



C. Insert the end window into the main body.

*NOTE: There are three very small tabs on the lip of the end window. Line those three tabs with the three long slots of the main body.*



D. Attach the three cam sleeves to the main body. Align the cam slots of the cam sleeve with the front and rear lens tabs.

*NOTE: Align one sleeve with the front and the rear lens and the other two sleeves with go on easier.*

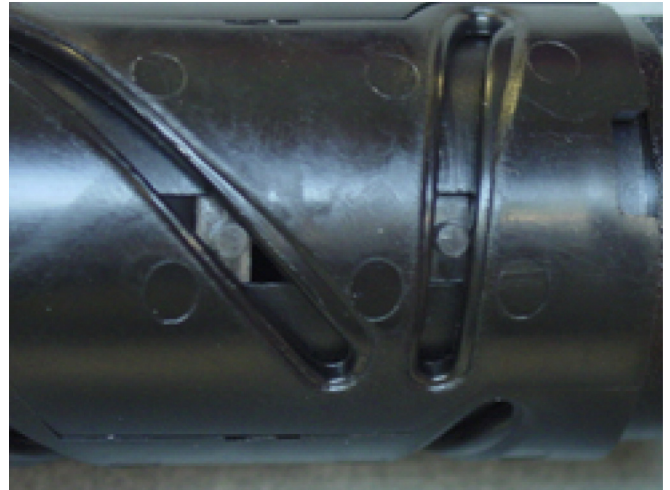

*NOTE: Observe how the front and the rear lens tabs, on the front and rear lens, fit in the cam sleeve.*

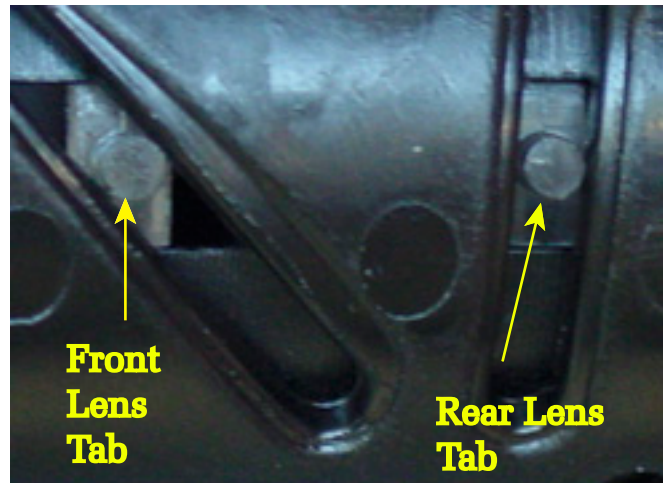

*Note: Observe that each cam sleeve has a slot at the rear of the cam sleeve. The slot must face toward the rear of the assembly.*

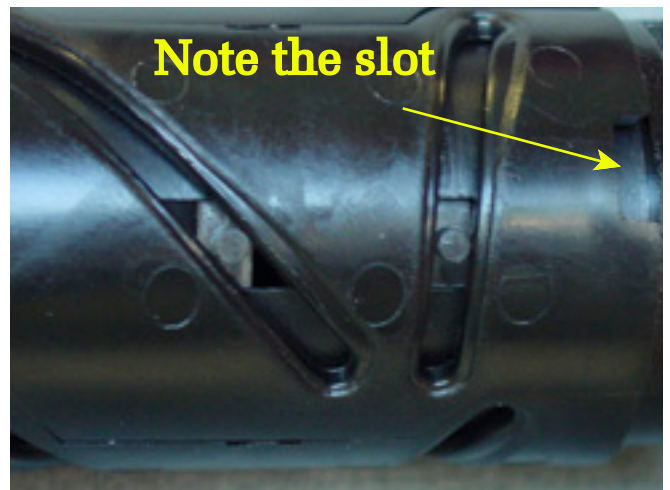



E. Slide the rear body over the main body assembly.

*NOTE: There are three tabs in the rear of the rear body. The rear body tabs will need to fit into the slots of the cam sleeves. You may have to rotate the rear body to get the rear body tabs to fit in the cam sleeve slots.*



F. Slide the front body over the assembly. You may have to rotate the front body. The front body will snap in place.





Bubble #	Part #	Description
1	236732	IEC CONNECTOR
2	488042	WIRE HARNESS,PWR MOD/GROUND S
3	488074-502	WIRE HARNESS, POWER MOD/SWITCH
4	488074-501	WIRE HARNESS,POWER MOD/SWITCH
5	236707-2	ILLUMINATED SWITCH-EXPORT 250VAC
6	488053	MOLEX HOUSING
7	106140-19	#6-32 X 1.375 PH,PN,ST,ZN
8	236733	FUSE DRAWER
9	236706-3114	FUSE 500MA USA
10	443071-1	TRANSFORMER, 35W
11	443093	SPARE WIRE CAPS
12	236706-3112	FUSE- 315 MA EUROPE, UK, Aus.
13	488307-4	FUSE-630 MA, JAPAN
14	761076-0	POWER CORD, DETACH.(DOM/JAPAN)
15	761076-2	POWER CORD-DETACH (EUROPEAN)
16	761076-4	POWER CORD-DETCHEBL(U.K)
17	761076-6	POWER CORD DETACH. (AUSTRALIA)
18	106130-2	QUICK CONNECT RECEPTACLE
19	488082	MOLEX CONNECTOR
20	48200	FIBER OPTIC LITE PIPE ASSY
21	48605	FOCUSING SLEEVE ASSEMBLY
22	488106	INNER SLEEVE
23	488401-2	BODY-MAIN,MACHINED
24	488406	CAM SLEEVE
25	488403	REAR LEANS
26	488405	END WINDOW
27	488408	FRONT OUTER BODY
28	488404	FRONT LENS
29	488407	REAR BODY
30	488035	RETAINING COLLAR
31	488034	INSULATOR
32	488311	FILTER-HEAT
33	106101-2	RETAINING RING
34	488432	BRAKE
35	488312	GASKET-HEAT FILTER
36	106113-22	SET SCREW, 6-32 X .125 CUP
37	488001-502	PIPE CONNECTOR ASSEMBLY
38	236707-1	ILLUMINATED SWITCH-DOMESTIC 125VAC
39	488118-501	REAR HOUSING, ASSY COMPLETE
40	747187	#8-32 HEX NUT-CAD PLTD
41	483412	#8 EXTERNAL LOCKWASHER
42	106137-2	NUT,8-32 EXTLOCK

Bubble #	Part #	Description
43	488110	KEYHOLE STANDOFF
44	488112	CAPTIVE PANEL SCREW
45	106140-3	4-40 X.25 W/EXT WASHER
46	488070	487 MODEL LABEL JAPAN
47	488069	487 MODEL LABEL (DOM)
48	488083	LAMP CHANGE LABEL
49	488071	487 MODEL LABEL EUROPE
50	488072	487 MODEL LABEL (AUST/UK)
51	455508	LABEL, PROTECTIVE EARTH GROUND
52	488089	CLIP REMOVAL LABEL
53	488116	WIRE TIE
54	443083	WIRE TIE W/MOUNTING HOLE
55	106100-4	PHPS 4-40 X .38 LG
56	488066	EMI SHIELD, 35W
57	488076-501	TRANSFORMER/WIRE HARNESS (DOM)
58	488043-503	FAN WITH WIRE HARNESS
59	488073-501	WIRE HARNESS LAMP/REC.BOARD
60	488058	LAMP HARNESS CONNECTOR
61	495073	LAMP HARNESS CONNECTOR
62	488077	LAMP CONNECTOR
63	106102-35	FHCS 4-40 X .75,NYLON BLACK
64	106109-13	NUT 4-40 SM,SM.HEX, STEEL ZINC
65	106140-18	3-48 X .250 PHP,ST.ZN W/WAS
66	488067-501	RECTIFIER BOARD
67	488063	MR16 LAMP HOLER
68	488084	35W BAFFLE
69	106137-1	NUT,4-40X.250 HEX,KEPS EXTLOCK
70	106102-40	FHPS #8-32 X .500
71	488023	BRACKET, WALL MOUNT
72	488206	MOUNTING PLATE 48780 ONLY
73	482205	RECEIVER BRACKET 48780 ONLY
74	488111	INSULATOR, TRANSFORMER
75	042000	HALOGEN LAMP-2 PIN
76	488011-2	FRONT COVER W/LOGO
77	488420-502	MOUNTING HARDWARE KIT
78	482200-501	FLEXIBLE FIBER OPTIC CABLE ASSY
79	106113-25	CUT PT.SET SCR,8-32X.25 STEEL
80	488082	Molex Connector
81	714160	Operation Instruction
82	488061	Service Manual

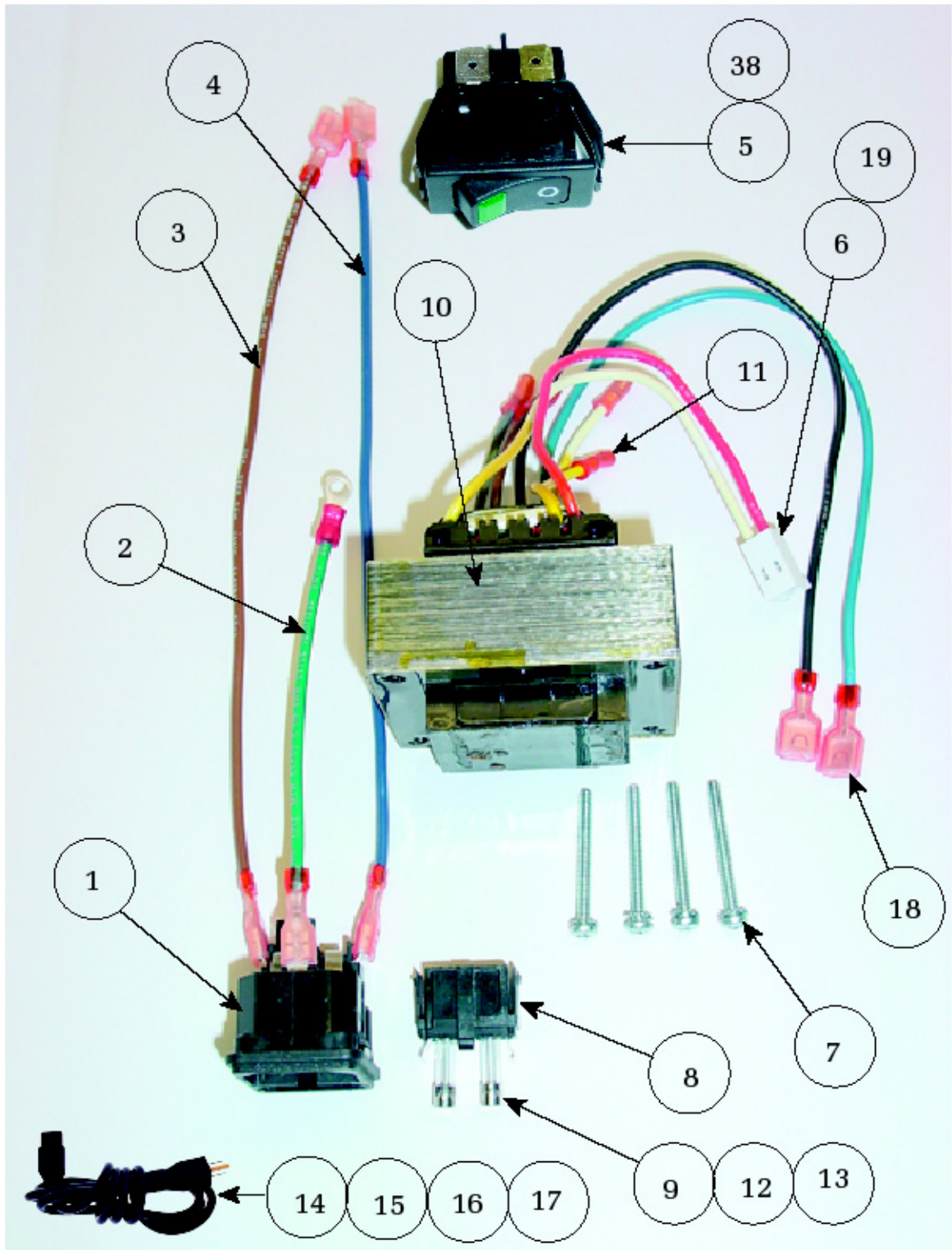

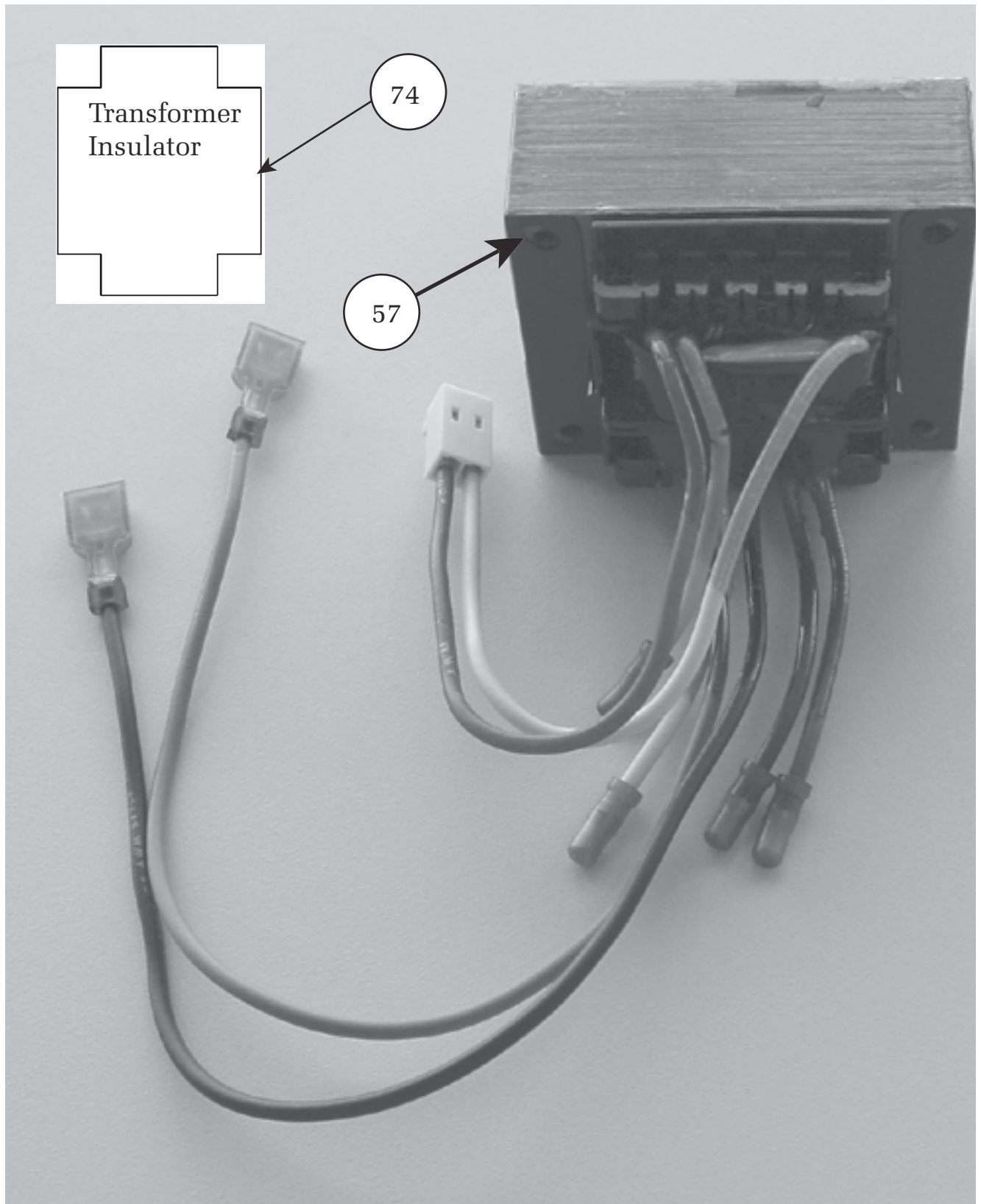

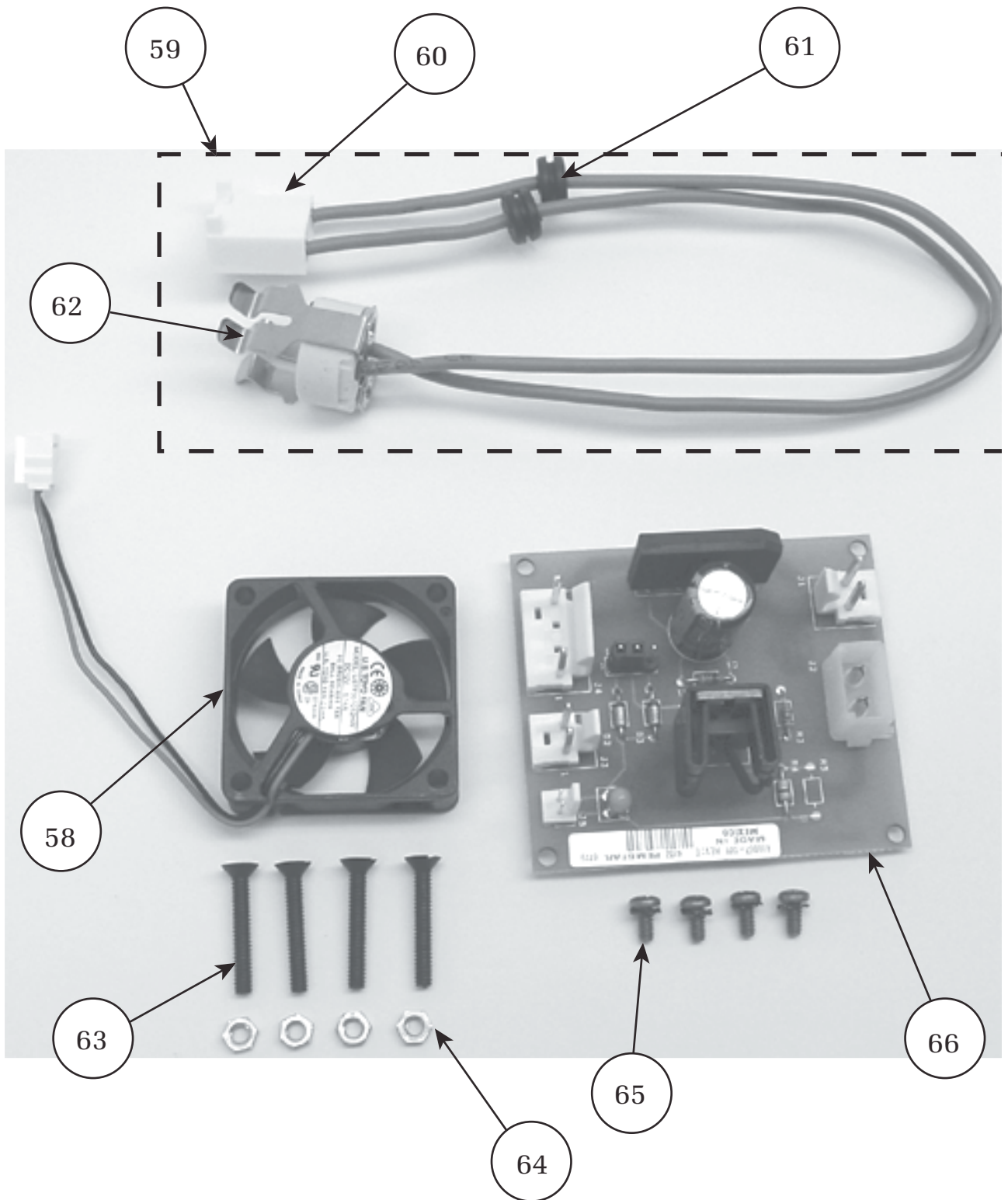



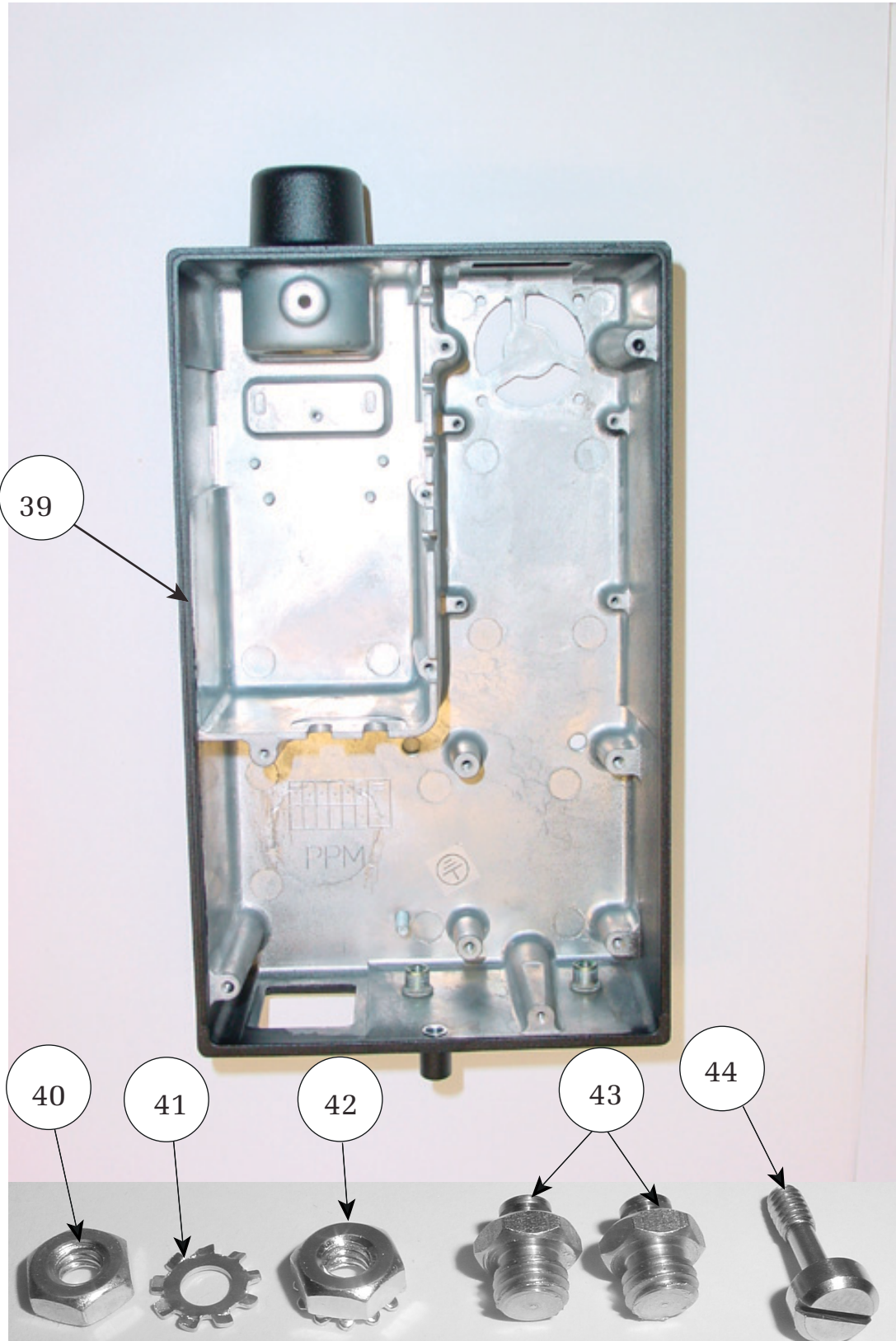

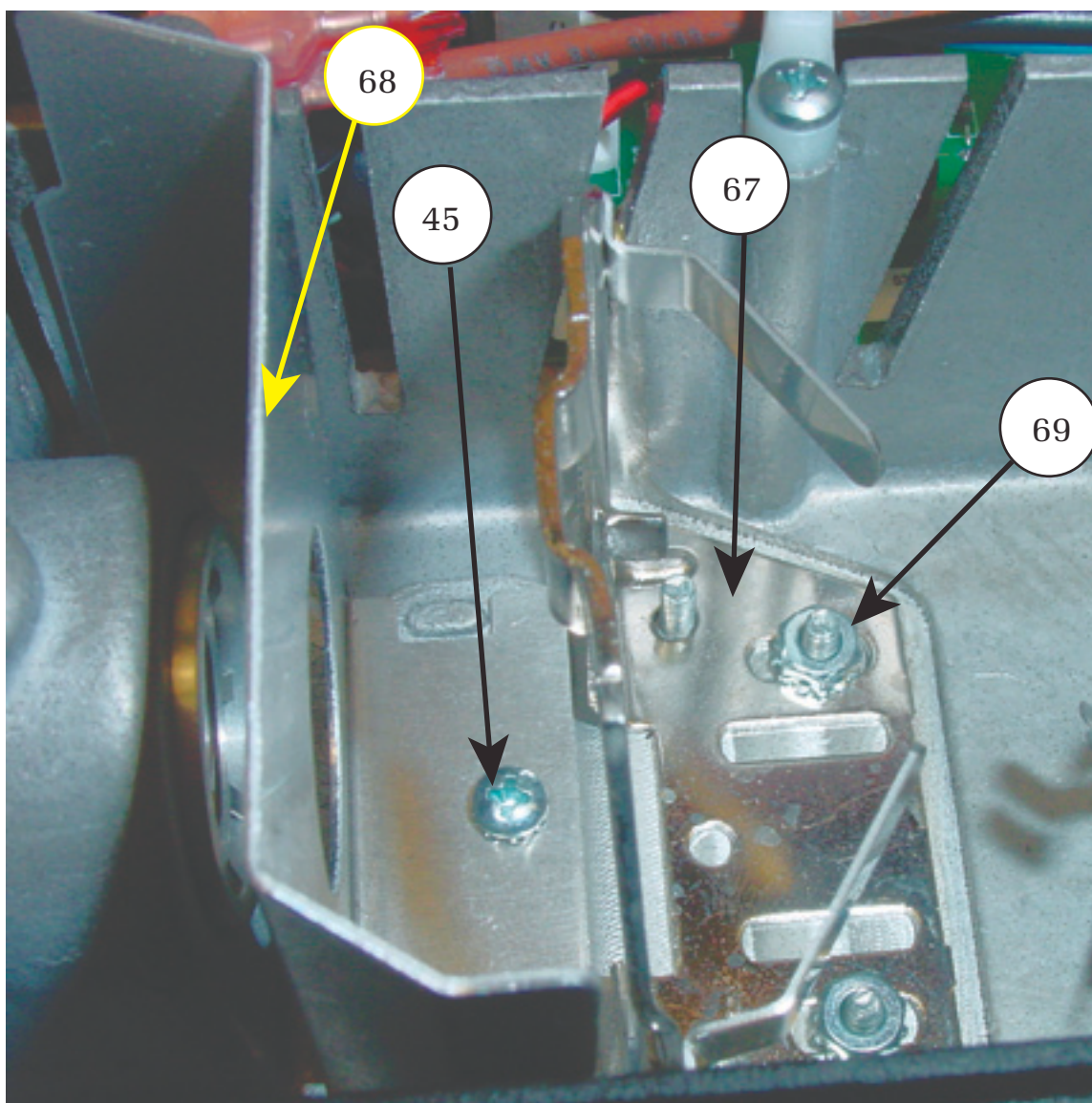

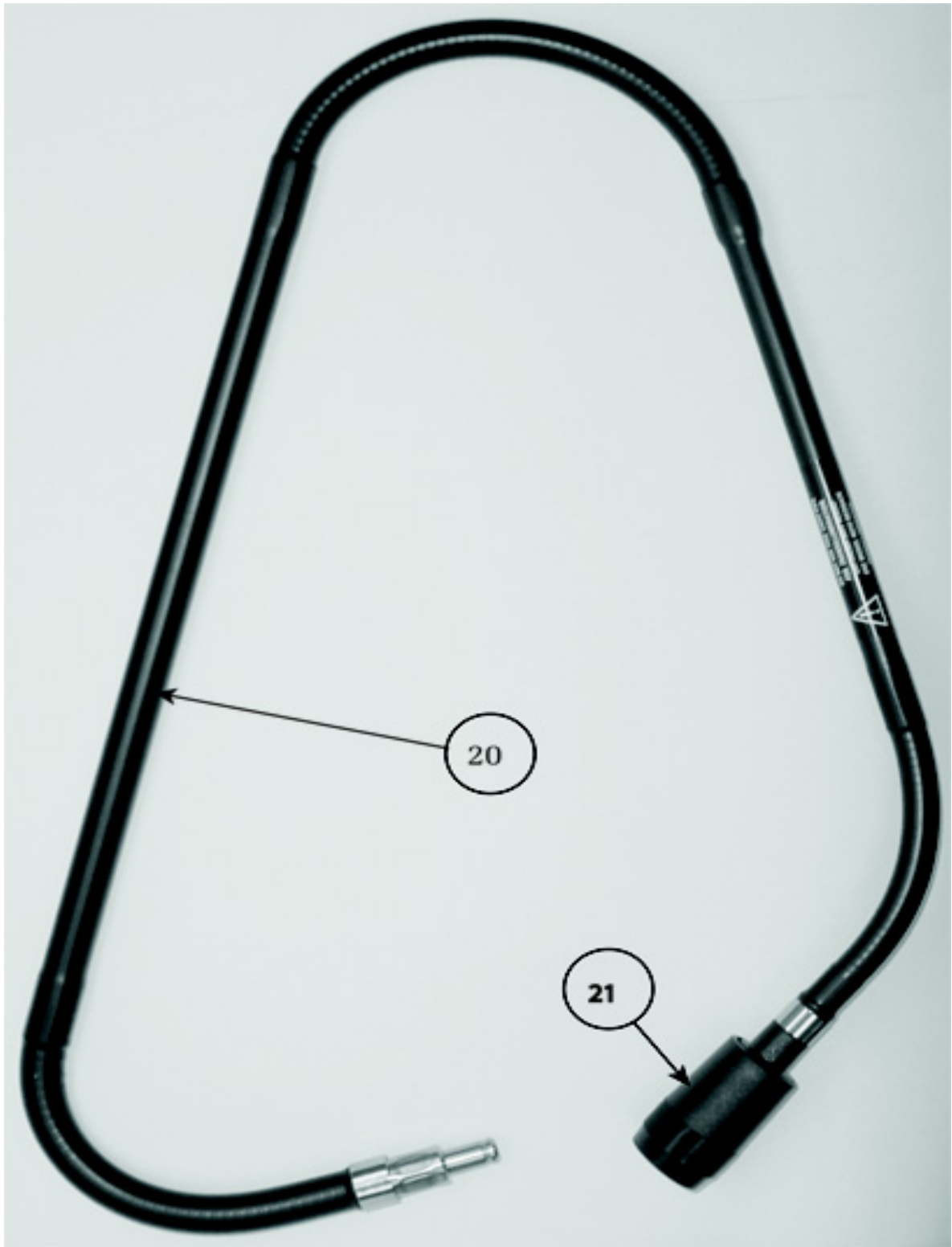



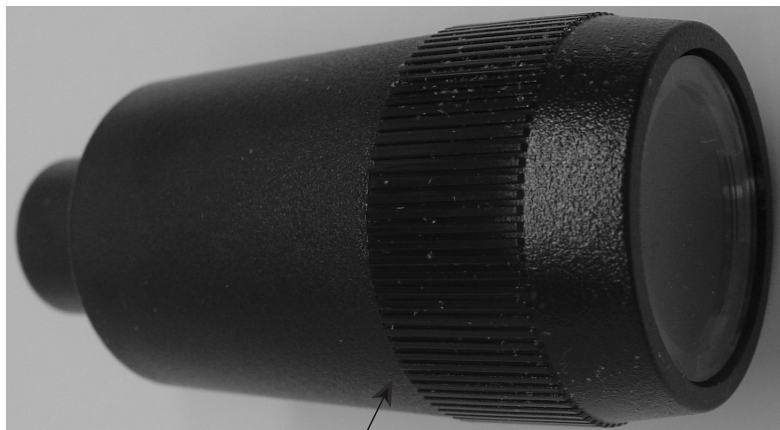

21

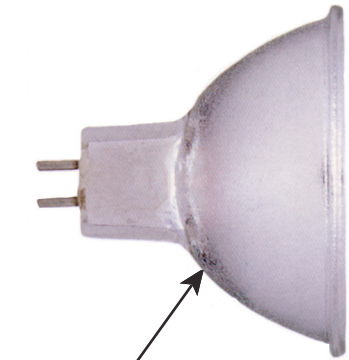

75

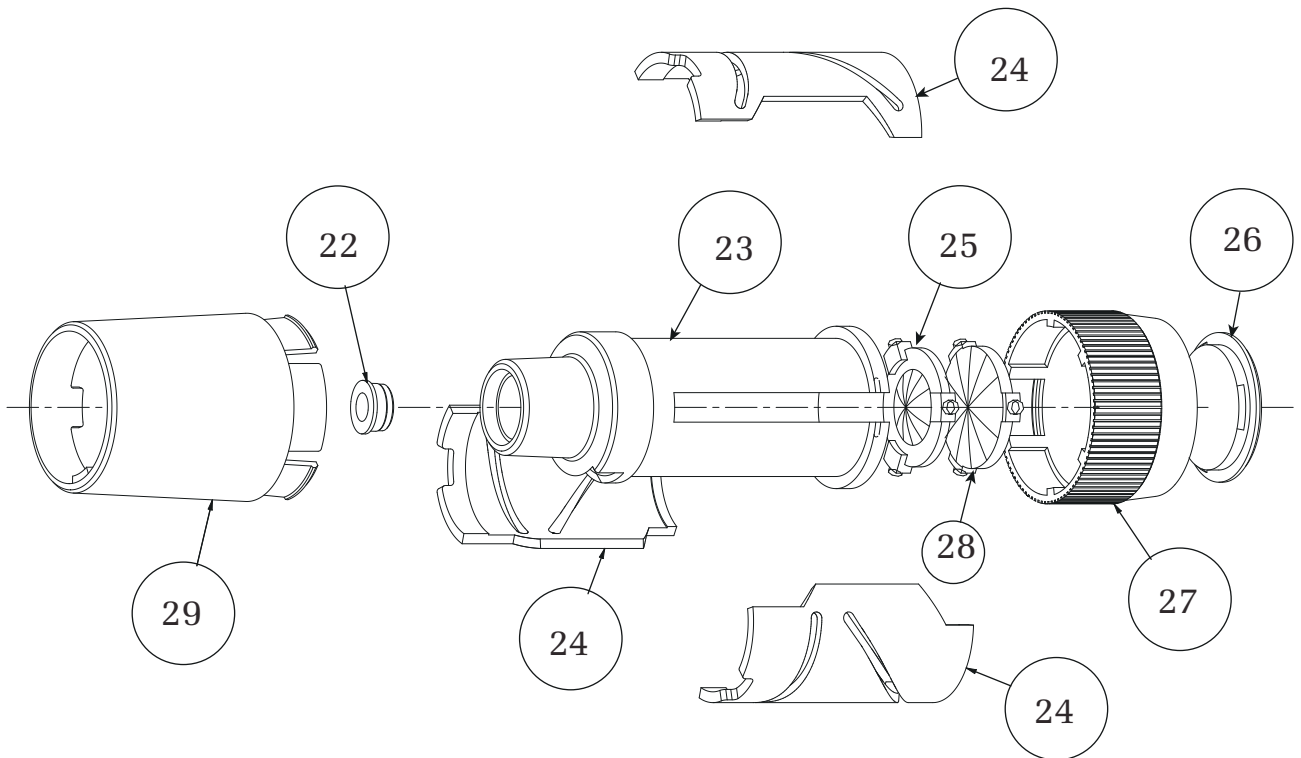

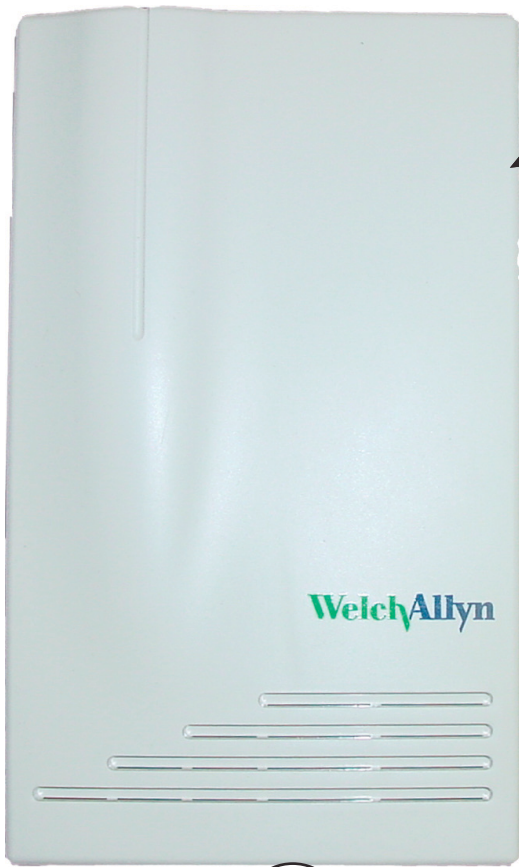

76

83

Neonate  
Lite  
Pipe

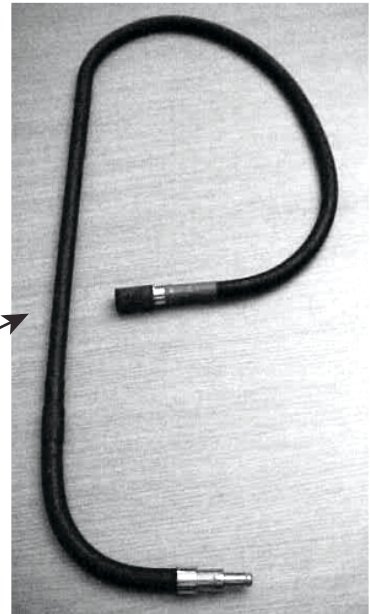

78

For the 48780

77



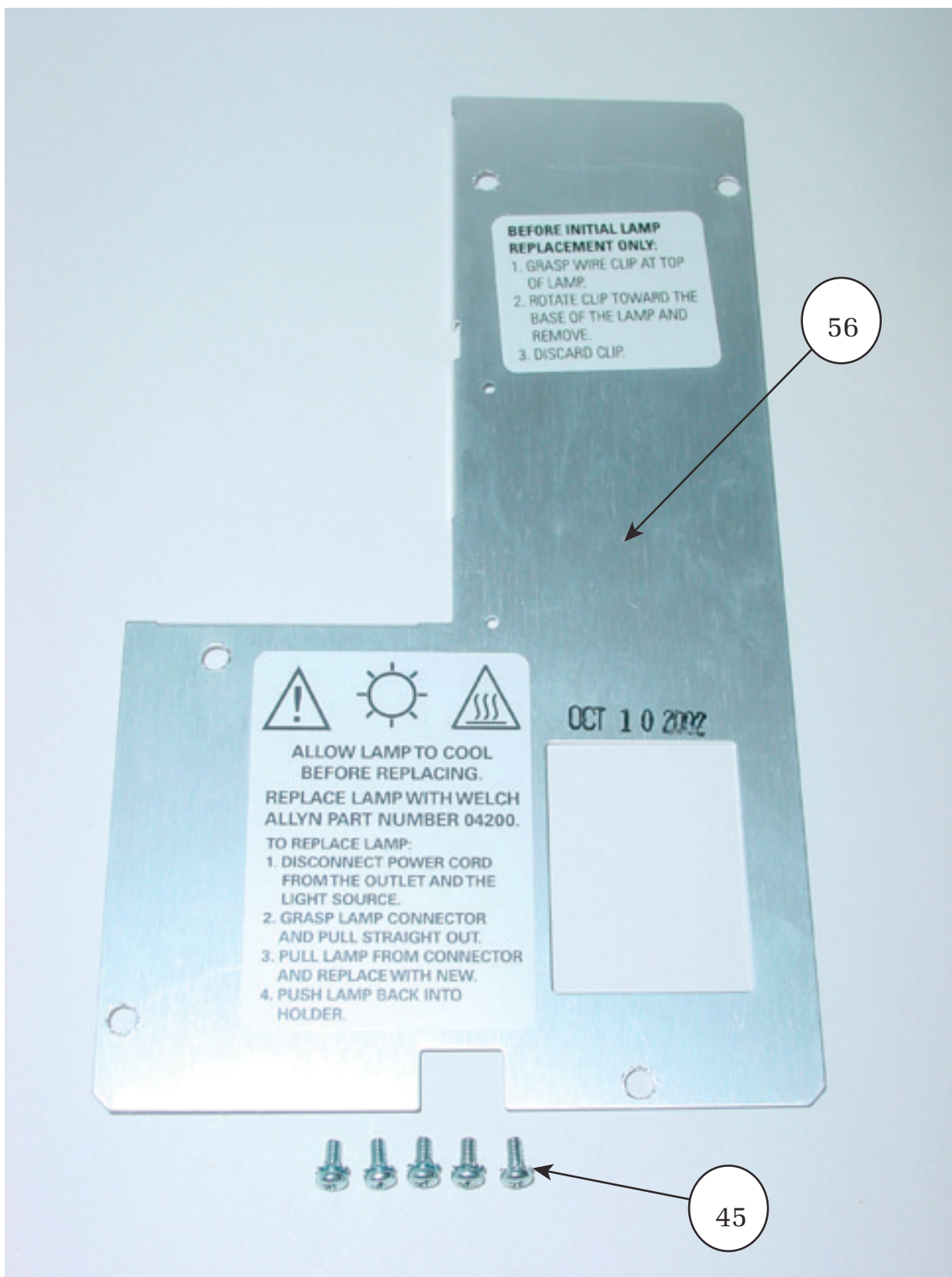



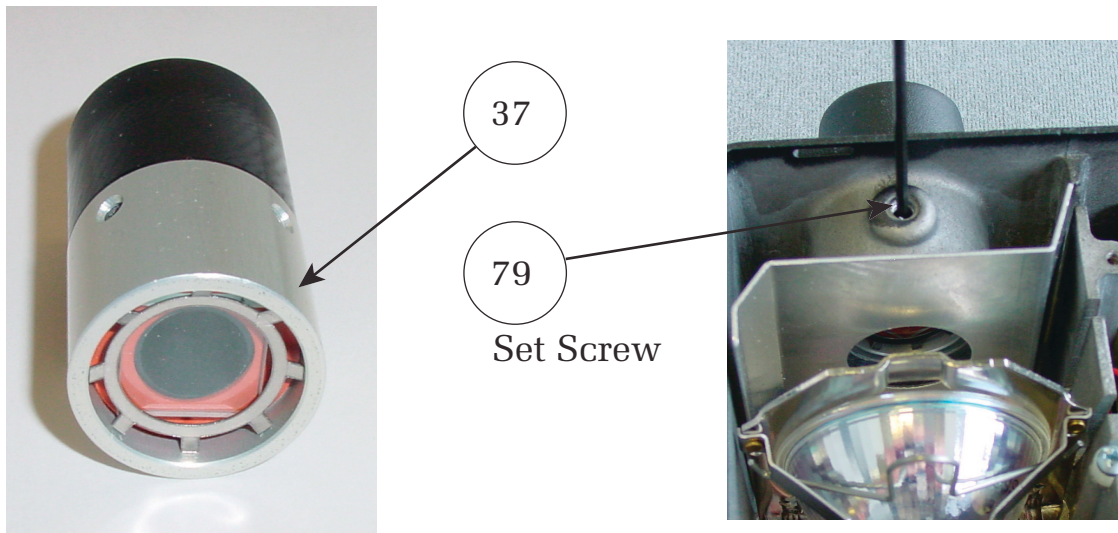
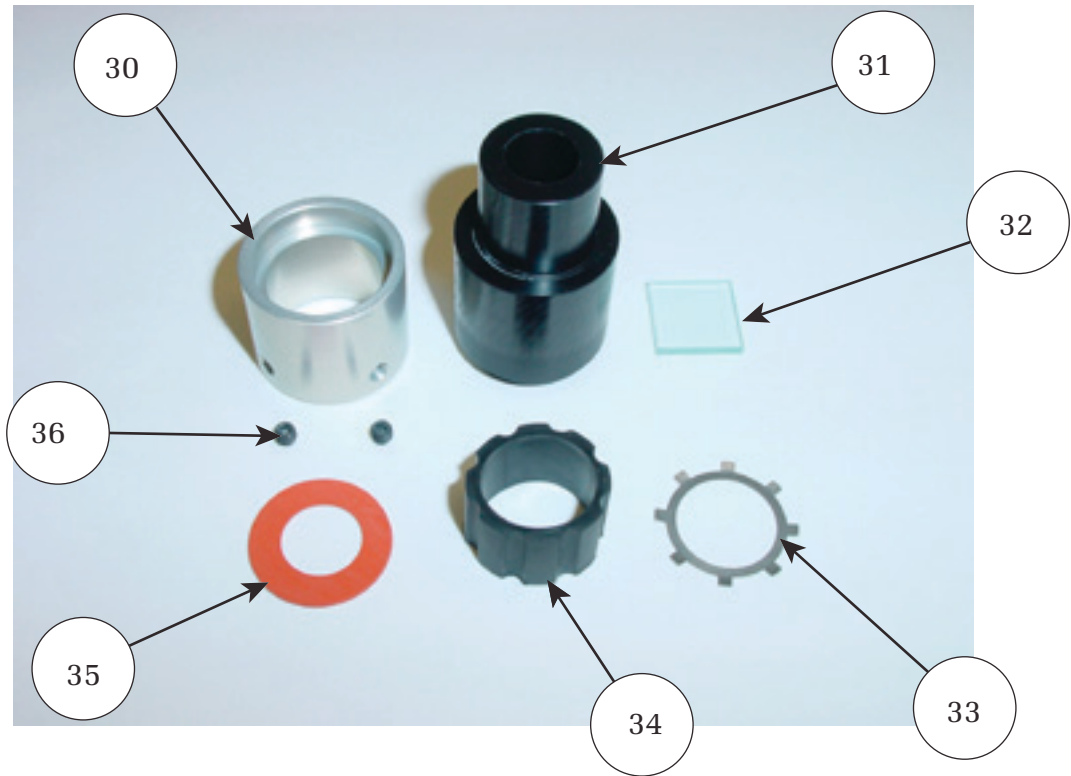



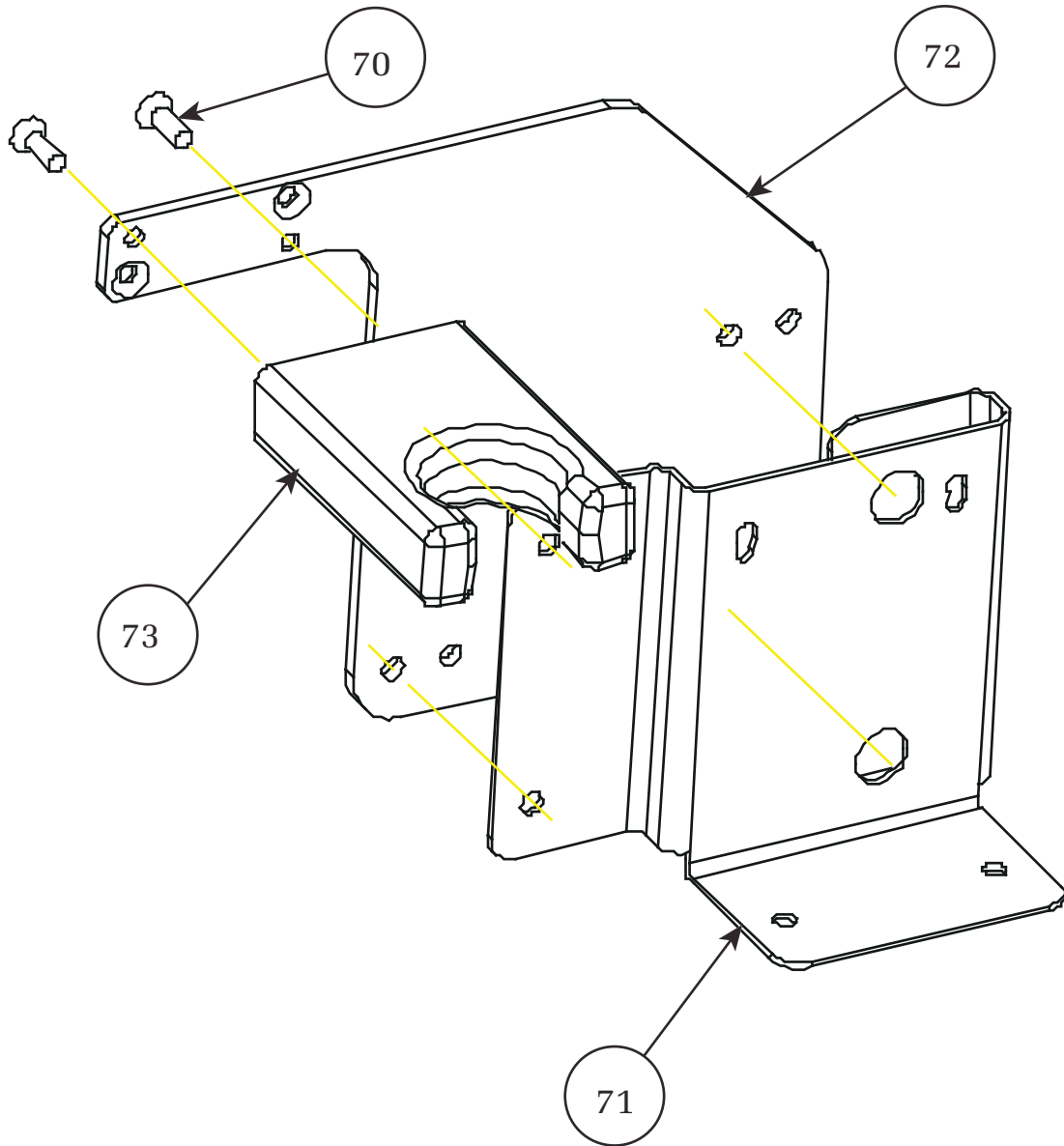

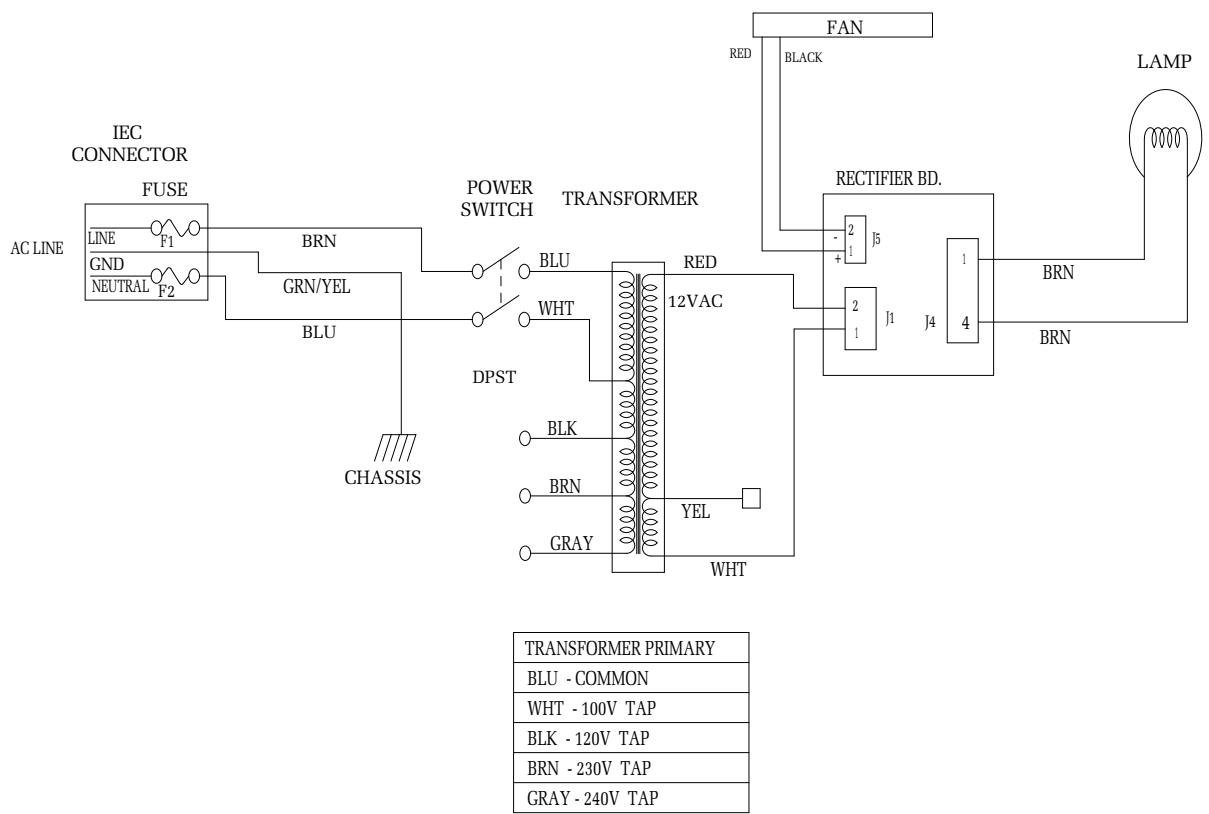

Blank Page