



Hillrom

The Vest Airway Clearance System, Model 105

Instructions for use
Product No. P105



145330 REV 22

Apply Serial Number Label here
or record Serial Number

Units with a 61-XXXXX serial number are manufactured by:

HILL-ROM, INC.
4349 CORPORATE ROAD
CHARLESTON, SC 29405

Units with a 62-XXXXX, 63-XXXXX, 64-XXXXX, or 65-XXXXX serial number are manufactured by:

HILL-ROM SERVICES PRIVATE LIMITED
1 YISHUN AVENUE 7
SINGAPORE 768923



WELCH ALLYN LIMITED
NAVAN BUSINESS PARK
DUBLIN ROAD
NAVAN, CO. MEATH
C15 AW22, IRELAND

Authorized Australian Sponsor:

This IFU is intended for use in Australia.
AUTHORIZED AUSTRALIAN SPONSOR
WELCH ALLYN AUSTRALIA PTY. LTD.
1 BAXTER DRIVE
OLD TOONGABBIE, NSW, 2146
AUSTRALIA

No part of this text shall be reproduced or transmitted in any form or by any means, electronic or mechanical, including photocopying, recording, or by any information or retrieval system without written permission from Hill-Rom Services PTE Ltd (Hillrom).

The information in this manual is confidential and may not be disclosed to third parties without the prior written consent of Hillrom.

The information in this manual is subject to change without notice. Hillrom makes no commitment to update or keep current, the information contained in this manual.

Hillrom reserves the right to make changes without notice in design, specifications, and models. The only warranty Hillrom makes is the express written warranty extended on the sale or rental of its products.

This manual (145330) was originally released and supplied in English. For a list of available translations, contact Hillrom.

Notice to Users and/or Patients in EU—Any serious incident that has occurred in relation to the device, should be reported to the manufacturer and the competent authority of the Member State in which the user and/or patient is established.

Product images and labels are for illustrative purposes only. Actual product and label may vary.

Twenty Second Edition, 2023-06

First Printing, 2007

Baxter, C3, Hillrom and The Vest are trademarks of Baxter International Inc. or its subsidiaries.

Any other trademarks, product names or brand images appearing herein are the property of their respective owners.

Replace this manual (145330) if it is damaged and/or can not be read.

For product support or to order additional copies of this manual (145330), contact Hillrom:

- In the USA, call Hillrom at 800-426-4224, or go to respiratorycare.hill-rom.com.
- Outside of the USA, contact your distributor or local Hillrom representative, or go to baxter.com.

Reference Documents

The Vest Airway Clearance System, Models 104, 105, and 205 Service Manuals (150574 – International).

Table of Contents

Intended Purpose.....	1
Intended Patient Population.....	1
Intended Users.....	1
Intended Medical Conditions.....	2
Indications for Use.....	2
Introduction.....	2
Symbols.....	3
Document Symbols.....	3
Product Symbols.....	3
Safety Instructions.....	9
Contraindications.....	9
Relative Contraindications.....	9
Features.....	15
Control Panel.....	15
Main Menu.....	15
Air Hose Connector Ports.....	16
Air Hoses.....	16
Remote Control.....	16
Inflatable Garment.....	17
Power Cord.....	17
Contour Foam (Optional).....	17
Instructions for Use.....	18
Setting Up the Unit.....	19
Fitting the Classic Chest Vest.....	22
Assemble the C3 Washable Garment.....	23
Fitting the C3 Washable Garment and the Classic Full Vest.....	24
Fitting the Classic Wrap Vest.....	26
Software Version.....	27
Use The Vest Airway Clearance System, Software Version 1.20....	28
Normal Mode.....	28
Set and Use the New Program Mode.....	30
Use the Program Mode.....	33
Set and Use the New Ramp Mode.....	35

Use the Ramp Mode.....	38
Check the Hour Meter Reading	40
Change the Language.....	41
Disable the Program Modes (Program and Ramp Modes)	42
Set Custom Default Settings.....	43
Use The Vest Airway Clearance System, Software Version 1.22 or 2.00 and Higher	46
Normal Mode	46
Set and Use the New Program Mode	48
Use the Program Mode	52
Set and Use the New Ramp Mode.....	55
Use the Ramp Mode.....	58
Check the Hour Meter Reading	61
Change the Language.....	61
Disable the Program Modes (Program and Ramp Modes)	62
Set Custom Default Settings.....	63
Cleaning	67
General Cleaning—Air Pulse Generator and Classic Garment Line.....	68
Do Not Steam Clean—Air Pulse Generator and Classic Garments	68
Cleaning Hard to Clean Spots—Air Pulse Generator and Classic Garments	68
C3 Garment Line Cleaning.....	69
Maintenance	70
Disposal Instructions	70
Expected Life.....	71
Device Errors	71
Service Calls.....	71
Troubleshooting	72
Air Pulse Generator Does Not Power On.....	72
No Air Pulses Into the Inflatable Garment	72
Screen Shows “Please Call for Service” Message	73
An Air Hose Comes out of the Air Pulse Generator or Inflatable Garment During Operation	73
Screen Shows “Restarting”.....	73

The Inflatable Garment No Longer Fits	73
Storage and Handling	74
Shipping the Unit	74
Specifications	75
Electromagnetic Compatibility Guidance	77
Frequently Asked Questions	83
Notes for The Vest System, Model 105 Users	84

INTENDED PURPOSE

The Vest Airway Clearance System, Model 105 was developed to provide effective Airway Clearance Therapy. The system consists of an inflatable garment attached to an Air Pulse Generator that rapidly inflates and deflates the inflatable garment. This causes the chest wall to be gently compressed and released, which creates airflow within the lungs. This process moves the mucus toward the large airways where it can be cleared by coughing or suctioning. This type of Airway Clearance Therapy is referred to as High Frequency Chest Wall Oscillation (HFCWO).



INTENDED PATIENT POPULATION

The Vest Airway Clearance System, Model 105 can be used for the pediatric to geriatric population. The system accommodates use across the targeted population by providing a selection of garment sizes which is used along with the air pulse generator.

INTENDED USERS

The users of the system are designated caregivers or patients in the home care environments. Users should have the ability to read and understand western Arabic numerals and the native language used in the manual. We recommend that the users of the device have an education level comparable to that of an 8th grader. We recommend that patients who do not meet this education level get assistance from caregivers or respiratory therapists while using this device for therapy.

INTENDED MEDICAL CONDITIONS

The intended medical conditions include, but are not limited to the following conditions:

- a. Secretion retention resulting in atelectasis and/or pulmonary infiltrates,
- b. Ineffective cough or secretion clearance due to immobility, deconditioning, or muscle weakness,
- c. Airway clearance dysfunction resulting in impaired ventilation and/or gas exchange.

INDICATIONS FOR USE

The Vest Airway Clearance System is intended to provide airway clearance therapy when external manipulation of the thorax is the physician's choice of treatment. Specific indications for external manipulation of the thorax include evidence or a suggestion of retained secretions, evidence that the patient is having difficulty with the secretion clearance, or presence of atelectasis caused by mucus plugging. In addition, **The Vest** Airway Clearance System is also indicated for external manipulation of the thorax to promote airway clearance or improve bronchial drainage for the purposes of collecting mucus for diagnostic evaluation.

INTRODUCTION

This manual includes instructions for setup, use, and maintenance of **The Vest** Airway Clearance System, Model 105. It is to be used as a reference guide. Please review all the sections carefully before you use the system.

The Vest Airway Clearance System, Model 105 is intended for use as prescribed by a physician.

SYMBOLS

DOCUMENT SYMBOLS

This manual contains different typefaces and symbols to make the content easier to read and understand:





- Standard text—used for regular information.
- **Boldface text**—emphasizes a word, phrase, or trademark.
- **NOTE:**—sets apart special data or important instruction clarification.
- WARNING or CAUTION:



















- A WARNING identifies situations or actions that may have an effect on patient or user safety. To ignore a warning or danger could cause patient or user injury.
- A CAUTION identifies special procedures or precautions that persons must obey to help prevent equipment damage.





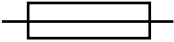

PRODUCT SYMBOLS





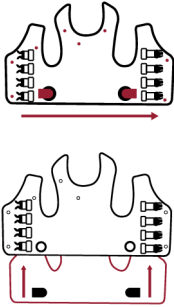
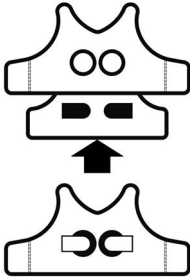





These symbols may or may not be used on your model of **The Vest** Airway Clearance System:







Symbol	Definition
	Type B equipment with an F-type applied part, according to EN 60601-1. (The Vest garment is the applied part and the maximum temperature on it will not exceed 107.1°F (41.7°C) under operating conditions.)
	Dangerous voltage within the device may constitute a risk of electrical shock (Not applicable to units compliant with ANSI/AAMI ES60601-1(2005) +AMD (2012).)
	ON button—starts the Air Pulse Generator (starts therapy, inflates the inflatable garment, starts the unit after being paused).
OFF 	OFF button—stops the Air Pulse Generator (stops therapy, pauses therapy).

Symbol	Definition
	Frequency setting
	Pressure setting
	Time setting
	Up arrow button—increases the Frequency, Pressure, or Time setting.
	Down arrow button—decreases the Frequency, Pressure, or Time setting.
	Remote Control port
	Attention: Consult accompanying documents. (Applicable to UL60601-1 compliant units.)
	Class II equipment (double insulated), according to EN60601-1.
<p>IP21</p>	Protected against ingress of an object of diameter 12.0 mm and vertically falling water drops.
	Read the operating instructions.

Symbol	Definition
	<p>Follow the operating instructions for use (IFU)—mandatory action.</p>
	<p>Medical—General Medical Equipment as to Electrical Shock, Fire, and Mechanical Hazards Only in Accordance with: ANSI/AAMI ES60601-1(2005) +AMD (2012) CAN/CSA-C22.2 No. 60601-1:14 E336914</p>
	<p>Devices with serial numbers 61-XXXXX and 62-XXXXX are in compliance with these standards: Medical Equipment with respect to electrical shock, fire, mechanical, and other specified hazards only in accordance with UL/EN/IEC 60601-1 and CAN/CSA C22.2 No. 601.1.</p>
	<p>The Vest Airway Clearance System, Model 105 conforms to the European Medical Device Directive 93/42/EEC.</p>
	<p>Identifies a replaceable fuse link in an electronic circuit.</p>
	<p>Environmental Protection: Waste electrical products should not be disposed of with household waste. Please recycle where facilities exist. Check with your Local Authority or a retailer for recycling advice.</p>
	<p>Do not spray.</p>
	<p>Cool iron only.</p>
	<p>Do not machine wash.</p>

Symbol	Definition
	Machine wash in cold water only.
	No chlorine bleach.
	Tumble dry.
	Bladder removal procedure (child small through adult sizes).
	Bladder installation procedure (child extra small size).
	Catalog number
	Batch number
	Serial number

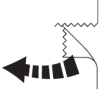
Symbol	Definition
	Medical Device
	Authorized Representative in the European Community
	Unique Device Identification
	Temperature for transport and storage
	Relative humidity for transport and storage
	Atmospheric pressure for transport and storage
	Fragile
	This end up
	Keep dry
	Stacking limit by number. The maximum number of identical packages which may be stacked on the bottom package.
	Date of manufacture

Symbol	Definition
	Manufacturer
	Manufacturer and date of manufacture
	Non sterile
	For multiple use on a single patient
<p data-bbox="154 683 253 711">Rx Only</p>	Physician prescription required (for US only).
	(Only for products to the Federative Republic of Brazil) InMetro Net Connection Corporation (NCC) logo
	Tear open here.
	(Only for products to the People's Republic of China) China RoHS2 (Standard No SJ/T 11364-2014) This product does not contain any hazardous substances exceeding concentration limits and is a green environmentally friendly product which can be recycled.
	Importer

SAFETY INSTRUCTIONS

CONTRAINDICATIONS



WARNING:

Warning—If the patient conditions exist that cause the use of **The Vest Airway Clearance System** to present a risk to the patient, **do not use the unit except as directed by a physician**. Death or serious injury could occur.

The Vest Airway Clearance System is **contraindicated** if these conditions are present:

- Head and/or neck injury that has not yet been stabilized
- Active hemorrhage with hemodynamic instability

RELATIVE CONTRAINDICATIONS

Use of the unit for Airway Clearance Therapy requires careful consideration and assessment of the individual patient's case if the following conditions exist:

- Intracranial pressure (ICP) greater than 20 mm Hg
- Recent spinal surgery or acute spinal injury
- Bronchopleural fistula
- Pulmonary edema associated with congestive heart failure
- Large pleural effusions or empyema
- Pulmonary embolism
- Rib fractures, with or without flail chest
- Surgical wound or healing tissue or recent skin grafts or flaps on the thorax
- Uncontrolled hypertension
- Distended abdomen
- Recent esophageal surgery
- Active or recent gross hemoptysis
- Uncontrolled airway at risk for aspiration such as tube feeding or a recent meal
- Subcutaneous emphysema
- Recent epidural spinal infusion or spinal anesthesia
- Burns, open wounds, and skin infections on the thorax
- Recent placement of transvenous or subcutaneous pacemaker

- Suspected pulmonary tuberculosis
- Lung contusion
- Bronchospasm
- Osteoporosis or osteomyelitis of the ribs
- Coagulopathy
- Complaint of chest wall pain

READ ALL INSTRUCTIONS BEFORE USING

NOTE:

When using electrical products, especially when children are present, basic safety precautions should always be followed, including the following important safeguards.



WARNING:

Obey all **warnings** throughout the manual and also the safety information below to help prevent injury and/or equipment damage:

- **Warning**—Always unplug this product immediately after using.
- **Warning**—Patients that may have difficulty clearing secretions from the upper airway (such as those with Duchenne muscular dystrophy (DMD) or other advanced neuromuscular or neurological disorders) may require specialized therapy regiments involving manually or mechanically assisted coughing or other techniques in conjunction with **The Vest** Airway Clearance System, Model 105 therapy. Please consult your physician to determine if additional therapy is appropriate.
- **Warning**—Adult supervision is required to use the therapy on children.
- **Warning**—Close supervision throughout the treatment is necessary when this product is used by children or patients with physical limitations or impaired cognitive abilities.
- **Warning**—Keep the hoses and power cord away from children to avoid strangulation.
- **Warning**—Do not store or use the device around pets, pests, or unsupervised children.

**WARNING:**

(Warnings continued) Obey all **warnings** throughout the manual and also the safety information below to help prevent injury and/or equipment damage:

- **Warning**—We recommend your first use of this product be in a supervised setting such as a doctor's office or at home with a clinical trainer.
- **Warning**—Use this product only for its intended use as described in this manual. Do not use attachments not recommended by the manufacturer.
- **Warning**—Do not use unauthorized parts or accessories with this device.
- **Warning**—Use only Hillrom authorized Air Hoses and garments to avoid allergic skin reactions.
- **Warning**—If this product has a damaged power cord or plug, is not working properly, or has been dropped or damaged, do not operate it. For examination and repair, contact Hillrom.
- **Warning**—Keep the unit and its power cord away from heated surfaces.
- **Warning**—Do not use the device near to any heat source such as a fireplace or radiant heater.
- **Warning**—Do not use the device in a dusty environment.
- **Warning**—Do not use the device in a heavy moisture environment.
- **Warning**—Never drop or insert any inappropriate object into any opening on the unit.
- **Warning**—Read and follow all instructions for setup, use, and maintenance of **The Vest** Airway Clearance System. Failure to do so could cause patient injury or equipment damage.
- **Warning**—If conditions exist that prohibit using **The Vest** Airway Clearance System, do **not** use the unit. Death or serious injury could occur.
- **Warning**—Federal USA law restricts this device to sale by or on the order of a physician. Sale by or on the order of unauthorized persons can cause patient injury.



WARNING:

(Warnings continued) Obey all **warnings** throughout the manual and also the safety information below to help prevent injury and/or equipment damage:

- **Warning**—Only authorized personnel should service **The Vest** Airway Clearance System. Servicing by unauthorized personnel could cause personal injury or equipment damage.

NOTE:

If service is necessary, use this contact information:

- In the USA, call Hillrom at 800-426-4224, or go to respiratorycare.hill-rom.com.
- Outside of the USA, contact your distributor or local Hillrom representative, or go to baxter.com.
- **Warning**—The potential for electrical shock exists with electrical equipment. Failure to follow protocols may cause death or serious personal injury.
- **Warning**—If it is necessary to disconnect/isolate the device from the main power supply, disconnect the power cord plug from the power inlet socket on the back of the air pulse generator or disconnect the plug from the power outlet in the wall.
- **Warning**—Make sure the position of the air pulse generator is such that you can quickly, without obstruction, disconnect the power cord from the main power supply if necessary.
- **Warning**—If the display on the Air Pulse Generator is faulty, do **not** use the unit.
- **Warning**—Do **not** use **The Vest** Airway Clearance System on a conductive floor.
- **Warning**—Wait at least 2 to 4 hours after a meal before you use **The Vest** Airway Clearance System.
- **Warning**—If the Air Pulse Generator is wet or damp, do **not** plug it into a power source or use it. Patient injury, personal injury, or equipment damage could occur.
- **Warning**—Before cleaning, unplug the unit from its power source. Failure to do so could cause personal injury or equipment damage.
- **Warning**—Do not expose the unit to excessive moisture or immerse it in water.

**WARNING:**

(Warnings continued) Obey all **warnings** throughout the manual and also the safety information below to help prevent injury and/or equipment damage:

- **Warning**—Do **not** run the Air Pulse Generator without the inflatable garment and Air Hoses attached.
- **Warning**—Do not use harsh cleansers, solvents, or detergents.
- **Warning**—Retain the original packaging material. If shipping is required, the original packing material provides the best protection for **The Vest** Airway Clearance System.
- **Warning**—Do not eat or drink during a therapy session. To do so could cause a choking hazard.
- **Warning**—Discard **The Vest** Airway Clearance System product in accordance with your local government regulations.
- **Warning**—To protect the patient and caregiver from the total acoustical energy from the use of this device, make sure of these:
 - The device is not used by a patient and/or a caregiver more than a total of 12 hours each day.
 - When the device is in use, keep a distance of at least 1.64' (0.5 m) between the device and the patient and caregiver.
- **Warning**—This product can expose you to chemicals including Cadmium and Mercury, which are known to the State of California to cause cancer and birth defects or other reproductive harm. For more information, go to www.P65Warnings.ca.gov.
- **Warning**—**The Vest** Airway Clearance System, Model 105 is MR Unsafe. Do not expose the system to any magnetic resonance (MR) environment.

NOTES:

- The system may present a risk of projectile injury due to the presence of ferromagnetic materials that can be attracted by the MR magnet core.
- The system may not function properly due to the strong magnetic and radio frequency fields generated by the MR equipment.
- **Warning**—Some patients with seizure history may experience seizure during or after the therapy.



WARNING:

(Warnings continued) Obey all warnings throughout the manual and also the safety information below to help prevent injury and/or equipment damage:

- **Warning**—Some patients may experience nausea, dizziness or headache when using the therapy. It is recommended that patients refrain from doing any therapy for a period of time after eating. If patients experience these symptoms, it is recommended that they take breaks during therapy.
- **Warning**—Patients that have external ports or equipment (for example, catheters, feeding tubes, tracheostomy tubes) should take care to cushion the site and/or support the equipment before initiating therapy.
- **Warning**—For patients with breast implants, make sure that you follow the doctor's prescriptions and exercise caution before you conduct the therapy.
- **Warning**—Changing prescribed settings, an unadjusted or ill-fitting garment may cause an ineffective therapy or lead to patient injury.
- **Warning**—Consult your physician prior to changing prescribed settings. Failure to do so can cause personal injury.

SAVE THESE INSTRUCTIONS

FEATURES



Air Pulse Generator

A	Air Pulse Generator	D	Remote Control
B	Air Hose Connection Ports	E	Control Panel
C	Air Hoses		

When correctly connected, the Air Pulse Generator controls the inflatable garment and supplies pulsations to the chest wall.

CONTROL PANEL

Pressing the **ON** or **OFF** controls or the 6 **Up** and **Down** arrow buttons, activates or deactivates features/functions on the Air Pulse Generator.

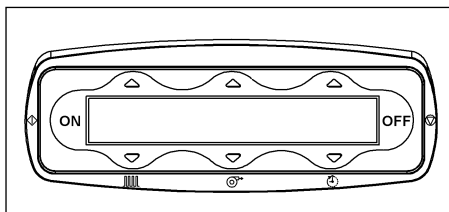

MAIN MENU

The Main Menu is shown when the Air Pulse Generator is powered on and ready for therapy or options selection.

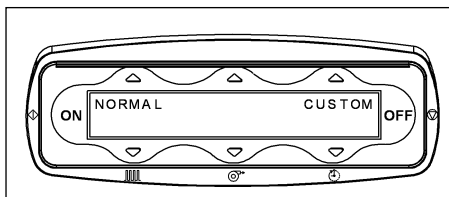

AIR HOSE CONNECTOR PORTS

The Air Hoses connect to the Air Pulse Generator at the two Air Hose Connector Ports on the face of the Air Pulse Generator.

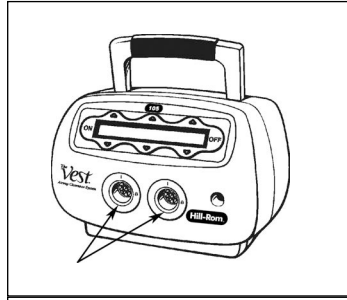

AIR HOSES

The Air Hoses connect the inflatable garment to the Air Pulse Generator.

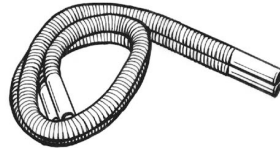

NON LOCKING

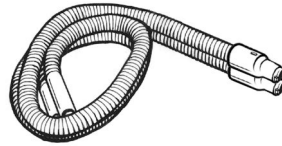

LOCKING

REMOTE CONTROL

The remote control is optional and can be used instead of the **ON/OFF** control to pause or resume the Air Pulse Generator.

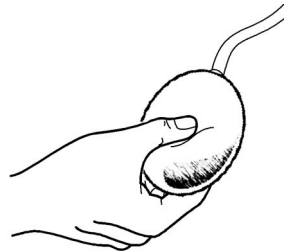
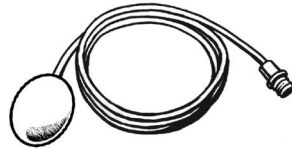

INFLATABLE GARMENT

The garment that you have will look like one of these:

- Chest Vest
- Full Vest
- Wrap Vest

When connected to the Air Pulse Generator by the Air Hoses, the inflatable garment is controlled by the Air Pulse Generator to provide pulsations to the chest wall. The most appropriate size garment will be provided to you with the Air Pulse Generator and other accessories.

NOTE:

The non-washable garments are referred to as the Classic Line, and the washable garments are referred to as the **C3** Garment Line.



Chest



Full Chest



Extra Small Full



Wrap

POWER CORD

The power cord plugs into the Air Pulse Generator and a power outlet.

NOTE:

The power cord required for your country may be different than shown.

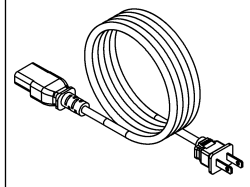

CONTOUR FOAM (OPTIONAL)

The contour foam (P/N 300177000) is an optional accessory. The foam helps provide comfort for the patient who has a Hickman catheter, portacath, and/or G-tube.

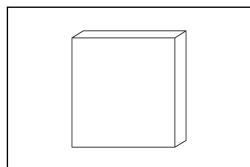

SETTING UP THE UNIT

Inspect the Air Pulse Generator and garments before each use. In addition, after each cleaning cycle, visually inspect each component for any wear, tear, or deformity. If you have any concern about a component, do not use it, and replace that component before the next therapy session. Failure to do so could cause injury.

NOTE:

If your physician has prescribed aerosol therapy to be used during the treatment, set up the appropriate equipment.



WARNING:

Warning—If the Air Pulse Generator is wet or damp, do **not** plug it into a power source or use it. Patient injury, personal injury, or equipment damage could occur.

1. Make sure the Air Pulse Generator is **not** wet or damp.
2. Put the Air Pulse Generator in a location that is stable and convenient.
3. Plug the power cord into the back of the Air Pulse Generator.
4. Plug the power cord into an applicable power outlet.

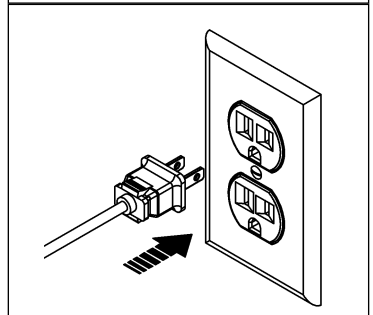
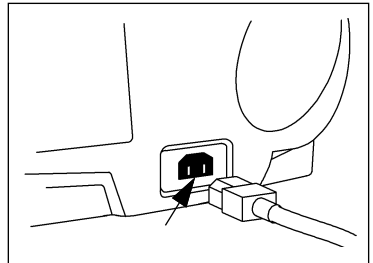

NOTE:

The power cord required for your country may be different than shown.

NOTE:

Once the unit is plugged in or the **ON** button is pressed, the following will show on the screen:

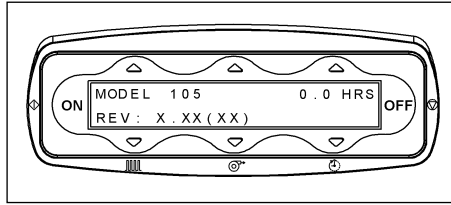

- a. The model number.
- b. The total number of hours the device has been used.
- c. The software revision.

NOTE:

To temporarily illuminate the backlight on the display, press any one of the six **Up** or **Down** arrow buttons.



CAUTION:

Caution—Do **not** run the Air Pulse Generator without the inflatable garment and Air Hoses attached. Equipment damage could occur.

5. Connect each Air Hose as follows:

Non-Locking Hose

- a. Connect the Air Hose to the Air Hose Connector Port on the front of the Air Pulse Generator.
- b. Slightly twist the Air Hose into the Air Hose Connector Port to help secure the Air Hose in position.

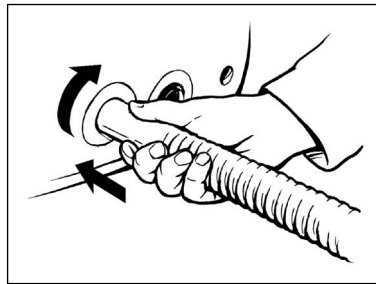

Locking Hose

- a. Align the mark on the Air Hose with the corresponding mark on the Air Hose Connector Port on the front of the Air Pulse Generator.
 - b. Turn the Air Hose to the locked position.
6. If the patient has a Hickman catheter, portacath, and/or G-tube, for the patient's comfort, it may help to use contour foam (P/N 300177000) around the port site. Install the foam as follows:

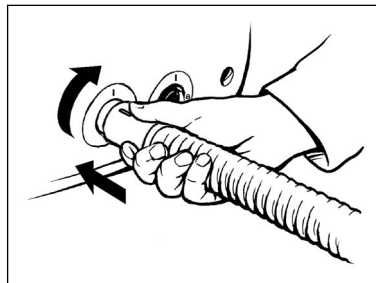

NOTE:

The contour foam is not sterile.

- a. Cut out a center hole to form a “donut” shape in the foam.

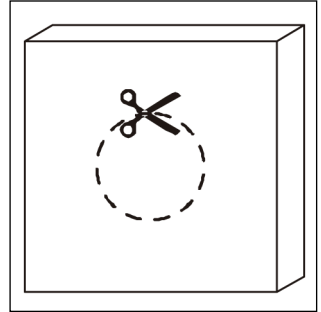

- b. Put the open hole of the foam “donut” directly over the port site.

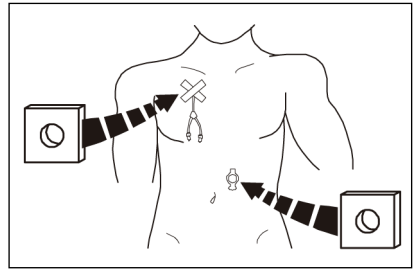

7. Fit the inflatable garment:

NOTE:

The Vest Airway Clearance System can be used with the patient in a sitting, lying down, or standing position.

- Chest Vest—refer to “Fitting the Classic Chest Vest” on page 22.
- Full Vest—refer to “Fitting the C3 Washable Garment and the Classic Full Vest” on page 24.
- Wrap Vest—refer to “Fitting the Classic Wrap Vest” on page 26.

8. Connect the Air Hoses to the ports on the inflatable garment.
9. Slightly twist the Air Hoses into the Air Hose Connector Ports to help secure the Air Hoses in position.

NOTE:

The connection of the Air Hoses to the Ports is the same for the locking and the non-locking hoses.

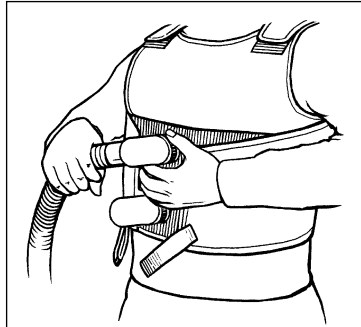

10. To use the optional remote control instead of the **ON** button, plug the remote control into the port on the front of the Air Pulse Generator.

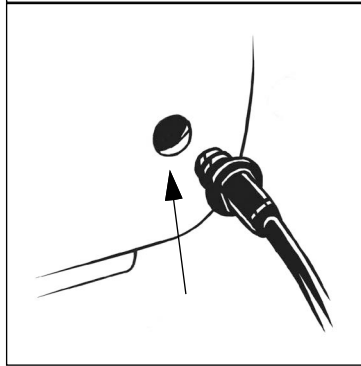

Fitting the Classic Chest Vest

NOTE:

It is recommended that a single layer of cotton clothing be worn beneath the inflatable garment to prevent static charge build-up.

1. Unfasten the back panel tabs from the main hook-and-loop fastener, and separate the front and back panels of the Chest Vest.
2. Turn the Chest Vest so the Air Hose Connector Ports are in front, and slide the Chest Vest over the head.

NOTE:

The Chest Vest can also be worn with the Air Hose Connector Ports in the back.

3. With the Chest Vest deflated, temporarily attach both back panel tabs of the Chest Vest to the front panel.



4. Adjust the hook-and-loop fasteners on the shoulder straps so the bottom of each arm opening of the Chest Vest is comfortably close to the underarm.
5. Detach both back panel tabs from the front of the Chest Vest.
6. For the best fit, inhale deeply, and then secure both back panel tabs to the front panel. You should be able to fit a flat hand between the Chest Vest and the body.
7. Make sure the Chest Vest fits close to the body without being uncomfortably snug.
 - To **tighten** the fit at the bottom edge, angle the back panel tabs **upward**.
 - To **loosen** the fit at the bottom edge, angle the back panel tabs **downward**.
8. Adjust the shoulder straps so that the bottom of each arm opening of the inflatable garment is comfortably close to the underarm.



Assemble the C3 Washable Garment

The **C3** Washable Garment will arrive to you in two pieces and will need to be assembled as follows. The Classic Full Vest does not need to be assembled, For the Classic Full Vest, go to “Fitting the C3 Washable Garment and the Classic Full Vest” on page 24.

To assemble the Child Small through Adult Sizes:

1. Lay the outer garment flat.
2. Open the zipper on the bottom of the outer garment.
3. Put the inflatable bladder into the outer garment.
4. Put the Air Hose Connector Ports through the outer garment.
5. Press the snaps to attach the bladder to the outer garment.

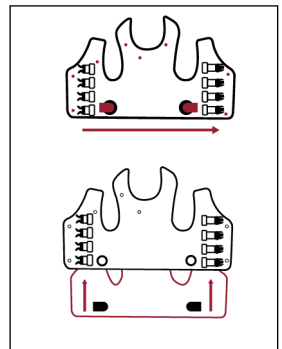

6. Close the zipper on the bottom of the outer garment.

To assemble the Child Extra Small Size:

1. Lay the outer garment flat.
2. Open the flap on the bottom of the outer garment.
3. Put the inflatable bladder into the outer garment.
4. Put the Air Hose Connector Ports through the outer garment.

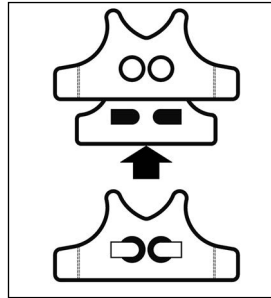

Fitting the C3 Washable Garment and the Classic Full Vest

Fitting the Child Small through Adult Sizes

NOTE:

It is recommended that a single layer of cotton clothing be worn beneath the inflatable garment.

1. Put the garment on so the closures are in front.

NOTE:

The garment can also be worn with the Air Hose Connector Ports in the back.

2. Connect the closures so the garment fits loosely over the chest.

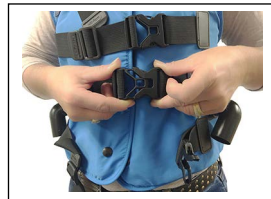

NOTE:

You should be able to fit a fist between the **C3** garment and the body before you inflate the garment. For the smallest (16") **C3** garment, you should be able to fit a flat hand between the garment and the body before inflating the garment.

3. Adjust the shoulder straps so the arm opening is just beneath the patient's underarms.



- Using the front closures, adjust the garment to fit close to the body without being uncomfortably snug:
 - To **tighten** the front closures, hold the buckle, and pull the end of the strap to the patient's right.
 - To **loosen** the front closures, gently lift the back of the buckle, and lengthen the strap.



- If any excess material is under the front closures, fold it under itself to make sure the garment fits correctly:
 - Loosen the front closures.
 - Fold the top flap under itself.
 - Tighten the front closures.



Fitting the Child Extra Small Size

It is recommended that a single layer of cotton clothing be worn beneath the inflatable garment.

- Put the garment on so the Air Hose Connector Ports are in the front.
- Connect the closures so the garment fits loosely over the chest:



NOTE:

You should be able to fit a flat hand between the garment and the body before you inflate the garment.

- Adjust the shoulder straps so the arm opening is just beneath the patient's underarms.



- Adjust the garment to fit close to the body without being uncomfortably snug:

- To **tighten** the fit at the bottom edge, angle the front panel tabs **upward**.



- To **loosen** the fit at the bottom edge, angle the front panel tabs **downward**.



Fitting the Classic Wrap Vest

NOTE:

It is recommended that a single layer of cotton clothing be worn beneath the inflatable garment.

- With the garment deflated, put the garment so it is perpendicular with the patient's torso.
- Put the garment in position just beneath the patient's underarms, and centered around the nipple line and continue to pull the garment around the patient's torso.
- Pull both ends of the garment around the patient's chest, and use the hook and loop fasteners to temporarily attach both ends to each other.



NOTE:

The garment can be worn with the Air Hose Connector Ports anywhere around the chest that is comfortable.

- Have the patient inhale deeply, and then attach the ends of the garment so it fits close to the body, but is not uncomfortable. You should be able to fit a flat hand between the garment and the body.

SOFTWARE VERSION

The software version is displayed on the start screen when the unit is connected to AC power.

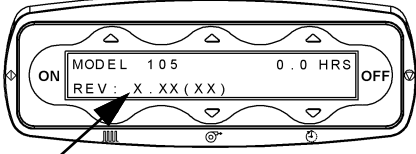
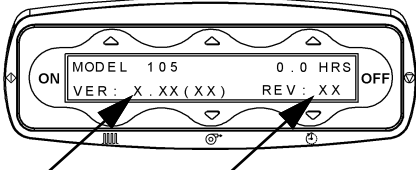
Software Version	Instructions
<p>1.20</p>	 <p>X.XX is the software version; (XX) is the software revision. Go to “Use The Vest Airway Clearance System, Software Version 1.20” on page 28.</p>
<p>1.22 or 2.00 and higher</p>	 <p>VER: X.XX (XX) is the software version; REV: XX is the software revision. Go to “Use The Vest Airway Clearance System, Software Version 1.22 or 2.00 and Higher” on page 46.</p>

USE THE VEST AIRWAY CLEARANCE SYSTEM, SOFTWARE VERSION 1.20

Make sure the unit is set up correctly. Once power is connected, the unit will show a blank screen for up to 15 seconds. Then it will show the model number and the total therapy hours for the unit. This screen shows for 10 seconds or until you press the **ON** button.

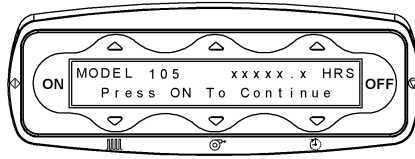

NOTE:

To show the total therapy hours, press the **OFF** button when the **Main** menu is shown.

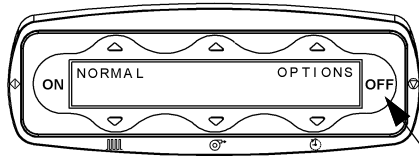

NORMAL MODE

The Normal mode is using one Frequency, Pressure, and Time settings for the entire therapy session.

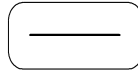

1. Press the **Up** arrow button above **NORMAL** for the standard operation mode. The screen will show the previously programmed Frequency, Pressure, and treatment Time settings (either factory settings or settings programmed by your clinical trainer based on your doctor's prescription).

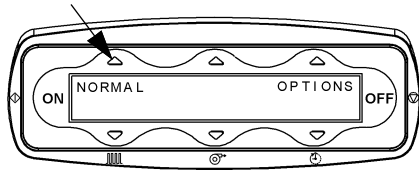

2. Confirm the settings on the screen. If the settings match the prescribed treatment, continue to step 3. Otherwise, adjust the settings to match the prescription.
 - a. To adjust the Frequency setting, press the left **Up** or **Down** arrow buttons until the prescribed treatment shows on the screen. The

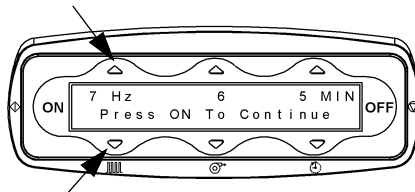

Frequency or Hertz (Hz) may be set between 5 and 20 cycles per second.

- b. To adjust the Pressure setting, press the middle **Up** or **Down** arrow buttons until the prescribed treatment Pressure shows on the screen.

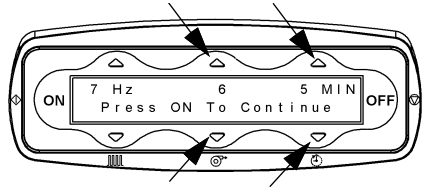

The Pressure may be set between 1 and 10.

- c. To adjust the treatment Time, press the right **Up** or **Down** arrow buttons until the prescribed treatment Time shows on the screen. The treatment Time may be set between 1 and 60 minutes.

NOTE:

It is not necessary to stop the treatment to adjust the settings.

3. Press the **ON** button. The inflatable garment will inflate.

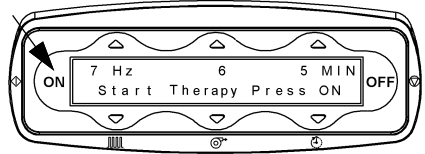

NOTE:

If the unit is left in this mode for 10 minutes, it will turn off.

4. Press the **ON** button again to begin the treatment. The set treatment Time shows as it counts down to zero.
5. If it is necessary to pause the treatment during a session, do as follows:

- a. Press the **OFF** button or the remote control once. The unit will stop the pulsations, but the settings will continue to show on the screen.

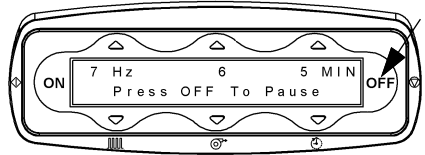

NOTE:

When the unit is paused, the inflatable garment will deflate.

- b. To resume treatment, press the **ON** button or the remote control again.

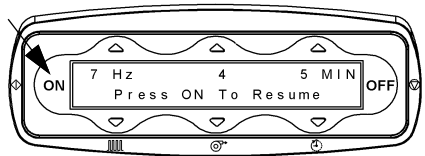

- If it is necessary to end the treatment session before it is complete, press the **OFF** button twice.

NOTE:

Pressing the **OFF** button does not turn off the screen.

- When the **OFF** button is pressed twice, the inflatable garment deflates and the “Incomplete X Min Remain” message shows on the screen. You must press the **ON** button to continue to the main screen.

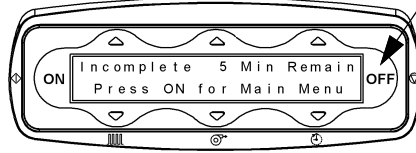

- When the treatment session is complete:

- The “Session Complete” message shows.
- The pulsations stop.
- The inflatable garment deflates.



- Unplug the system from its power source.
- Remove the Air Hoses from the Air Hose Ports on the inflatable garment.
- Remove the inflatable garment.

SET AND USE THE NEW PROGRAM MODE

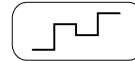

The New Program mode allows the programming of up to eight (8) different Programming Points, each with its own combination of Frequency, Pressure, and treatment Time.



WARNING:

Warning—Consult your physician prior to changing prescribed settings. Failure to do so can cause personal injury.

- Press the **ON** button.

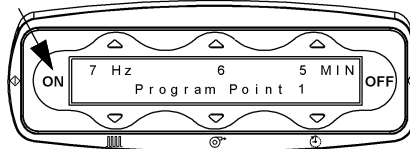

2. Press the **UP** arrow button above **OPTIONS**.
3. Press the **Down** arrow button below **New Pgm** to create a new program. The screen will show the Frequency, Pressure, and treatment Time settings for the first Programming Point.

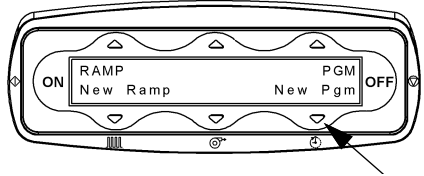
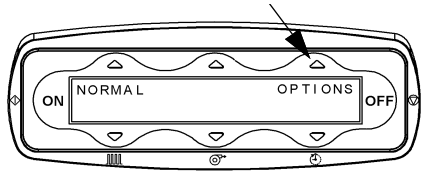

NOTE:

All the settings can be adjusted.

4. For Programming Point 1, if the settings match the prescribed treatment, continue to step 3.

Otherwise, adjust the settings to match the prescription by pressing the **Up** and **Down** arrow buttons associated with Frequency, Pressure, and treatment Time.

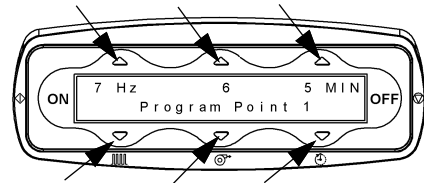

5. Once you have set Programming Point 1, proceed to Programming Point 2 by pressing the **ON** button (to move to a previous Programming Point, press the **OFF** button). Adjust the settings to match the prescription and repeat for all 8 Programming Points.

NOTE:

If the prescription does not call for all 8 Programming Points, **after** programming the last prescribed programming point, set the Time to 0 MIN for the following segment.

Once you change the Programming Point Time to 0 MIN and press the **ON** button, it will take you to the start of the program to begin therapy.

6. Press the **ON** button. The inflatable garment will inflate.

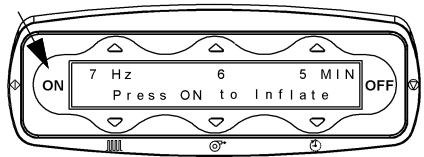

7. Press the **ON** button again to begin the treatment program. The set treatment Time shows as it counts down to zero for each Programming Point.

8. Therapy will automatically end after it has gone through each Programming Point.
9. If it is necessary to pause the treatment during a session, do as follows:

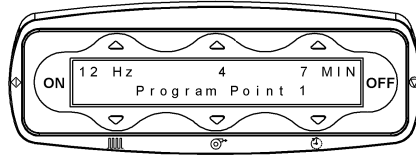

- a. Press the **OFF** button or the remote control once. The unit will stop the pulsations, but the settings will continue to show on the screen.

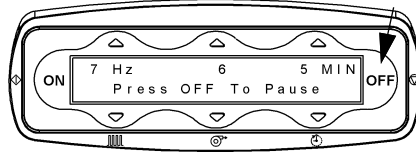

NOTE:

When the unit is paused, the inflatable garment will deflate.

- b. To resume treatment, press the **ON** button or the remote control again.

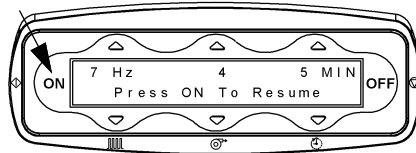

10. If it is necessary to end the treatment session before it is complete, press the **OFF** button twice.

NOTE:

Pressing the **OFF** button does not turn off the screen.

11. When the **OFF** button is pressed twice, the inflatable garment deflates and the "Incomplete X Min Remain" message shows on the screen. You must press the **ON** button to continue to the Program and Ramp main screen.

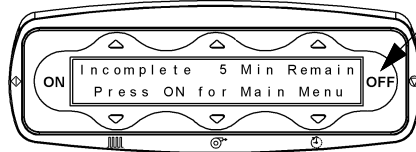

12. When the treatment session is complete:
 - a. The “Session Complete” message shows.
 - b. The pulsations stop.
 - c. The inflatable garment deflates.

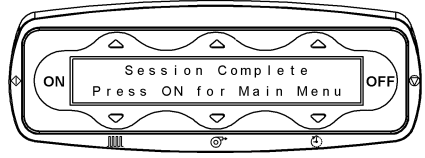

13. Unplug the system from its power source.
14. Remove the Air Hoses from the Air Hose Ports on the inflatable garment.
15. Remove the inflatable garment.

USE THE PROGRAM MODE

Runs a previously created **New** Program mode. See “Set and Use the New Program Mode” on page 30.

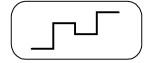

WARNING:

Warning—Consult your physician prior to changing prescribed settings. Failure to do so can result in personal injury.

1. Press the **ON** button.

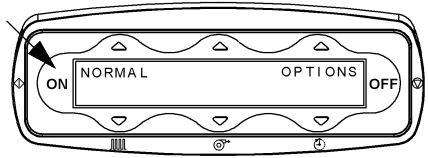

2. Press the **UP** arrow button above **OPTIONS**.

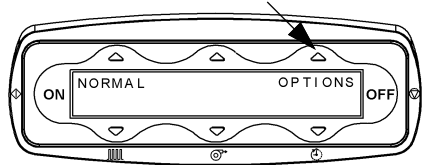

3. Press the **Up** arrow button above **PGM** to run the previously created program, or selected default program.

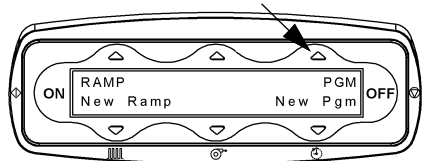

4. Press the **ON** button. The inflatable garment will inflate.

5. Press the **ON** button again to begin the treatment program. The set treatment Time shows as it counts down to zero for each Programming Point.

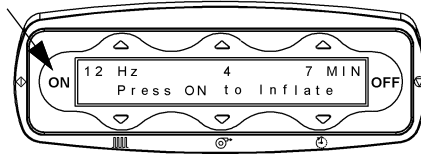

6. The therapy will automatically end after it has gone through each of the Programming Points.

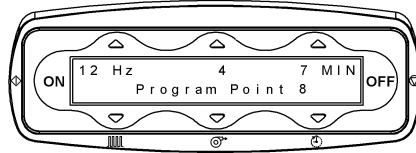

7. If it is necessary to pause the treatment during a session, do as follows:

- a. Press the **OFF** button or the remote control once. The unit will stop the pulsations, but the settings will continue to show on the screen.

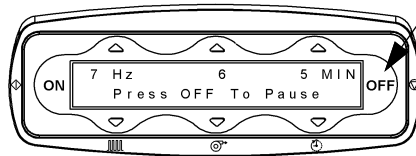

NOTE:

When the unit is paused, the inflatable garment will deflate.

- b. To resume treatment, press the **ON** button or the remote control again.

8. If it is necessary to end the treatment session before it is complete, press the **OFF** button twice.

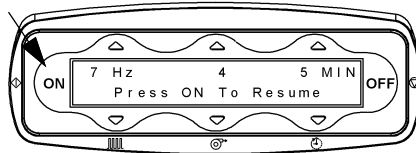

NOTE:

Pressing the **OFF** button does not turn off the screen.

9. When the **OFF** button is pressed twice, the inflatable garment deflates and the "Incomplete X Min Remain" message shows on the screen. You must

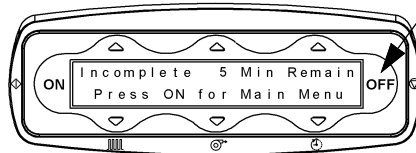

press the **ON** button to continue to the Program and Ramp main screen.

10. When the treatment session is complete:

- The "Session Complete" message shows.
- The pulsations stop.
- The inflatable garment deflates.



11. Unplug the system from its power source.

12. Remove the Air Hoses from the Air Hose Ports on the inflatable garment.

13. Remove the inflatable garment.

SET AND USE THE NEW RAMP MODE

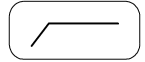

Creates a new Ramp Program to ease the patient from a lower setting to a higher setting during a limited period of the therapy session.



WARNING:

Warning—Consult your physician if not using the prescription as provided. Failure to do so can result in personal injury.

1. Press the **ON** button.

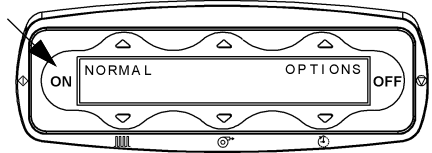

2. Press the **UP** arrow button above **OPTIONS**.

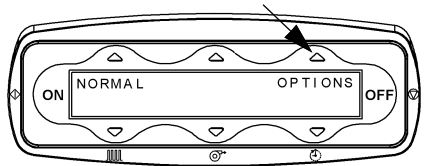

3. Press the **Down** arrow button below **New Ramp** to adjust the program settings.

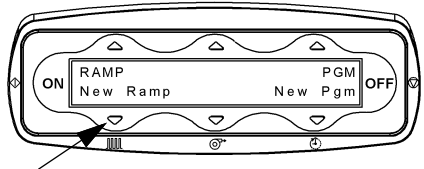

4. Look at the settings on the screen. **Ramp Time Percent** is the portion of the treatment Time required to increase from the initial settings (**Ramp Start**) to the final settings (**Ramp End**). To adjust the percent to the prescribed therapy, press the right **Up** or **Down** arrow buttons.

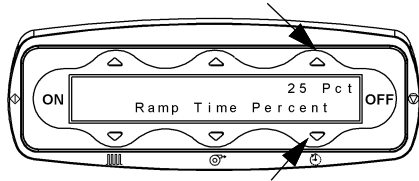

5. Press the **ON** button to advance to the next screen.
6. Review the settings for Frequency and Pressure for the initial setting, **Ramp Start**.

- a. To adjust the Frequency setting, press the left **Up** or **Down** arrow buttons until the prescribed treatment shows on the screen. The Frequency (or Hertz (Hz)) may be set between 5 and 20 cycles per second.

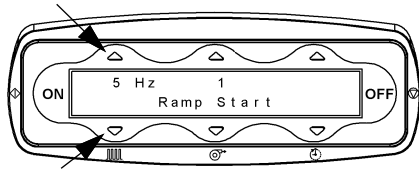

- b. To adjust the Pressure setting, press the middle **Up** or **Down** arrow buttons until the prescribed treatment Pressure shows on the screen. Pressure may be set between 1 and 10.

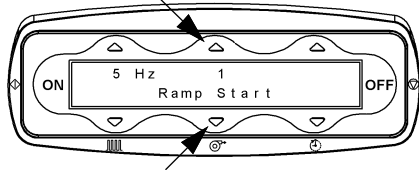

7. Press the **ON** button to advance to the next screen.
8. Review the settings on the screen. Frequency and Pressure for the final setting, **Ramp End**, are shown as treatment Time.
 - a. To adjust the Frequency setting, press the left **Up** or **Down** arrow buttons until the prescribed setting shows on the screen. Frequency or Hertz (Hz) may be set between the Ramp Start setting and 20 cycles per second.
 - b. To adjust the Pressure setting, press the middle **Up** or **Down** arrow buttons until the prescribed setting shows on the screen. Pressure may be set between the Ramp Start setting and 10.

- c. To adjust the treatment Time, press the right **Up** or **Down** arrow buttons until the prescribed treatment Time shows on the screen.

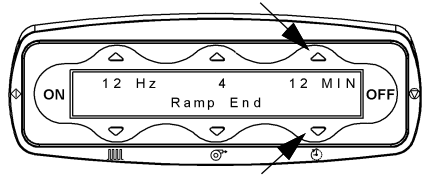

The treatment Time may be set between 1 and 60 minutes.

9. Press the **ON** button to advance to the next screen. This screen shows the summary of the ramp program you have just created.

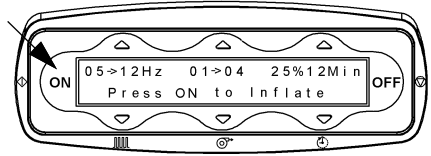

10. Press the **ON** button. The inflatable garment will inflate.

11. Press the **ON** button again to begin the therapy. The screen will show the word "Ramping" during the ramp portion of the program. The total treatment Time shows as it counts down to zero.

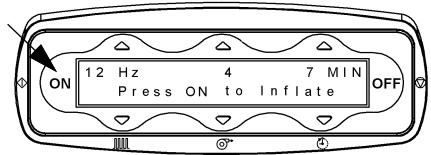

NOTE:

Therapy settings **can not** be changed during Ramping stage.

12. If it is necessary to pause the treatment during a session, do as follows:
- Press the **OFF** button or the remote control once. The unit will stop the pulsations, but the settings will continue to show on the screen.

NOTE:

When the unit is paused, the inflatable garment will deflate.

- To resume treatment, press the **ON** button or the remote control again.

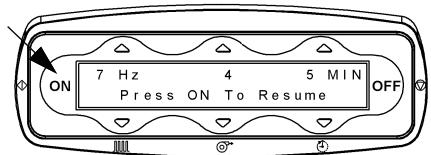

13. If it is necessary to end the treatment session before it is complete, press the **OFF** button twice.

NOTE:

Pressing the **OFF** button does not turn off the screen.

14. When the **OFF** button is pressed twice, the inflatable garment deflates and the “Incomplete X Min Remain” message shows on the screen. You must press **ON** to continue to the main screen.

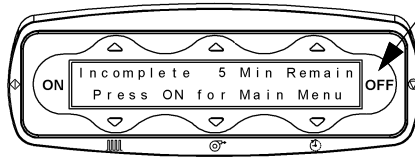

15. When the treatment session is complete:

- a. The “Session Complete” message shows.
- b. The pulsations stop.
- c. The inflatable garment deflates.



16. Unplug the system from its power source.
17. Remove the Air Hoses from the Air Hose Ports on the inflatable garment.
18. Remove the inflatable garment.

USE THE RAMP MODE

Runs a previously created Ramp Program. See “Set and Use the New Ramp Mode” on page 35.

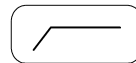

WARNING:

Warning—Consult your physician if not using the prescription as provided. Failure to do so can result in personal injury.

1. Press the **ON** button.

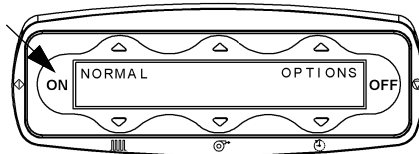

2. Press the **UP** arrow button above **OPTIONS**.

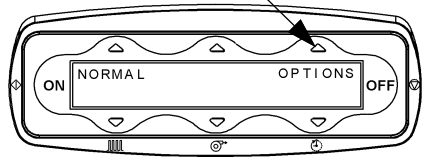

3. Press the **Up** arrow button above **RAMP** to run the previously created ramp program.

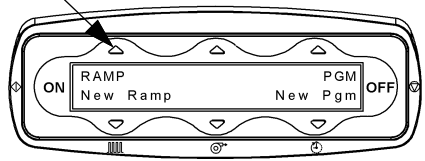

4. The programmed points will be shown. Press the **ON** button to advance to the next screen.

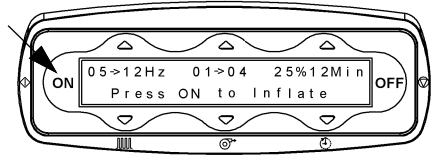

5. Press the **ON** button. The inflatable garment will inflate.

6. Press the **ON** button again to begin the program. The screen will show the word "Ramping" during the ramp portion of the program. The total treatment Time shows as it counts down to zero.

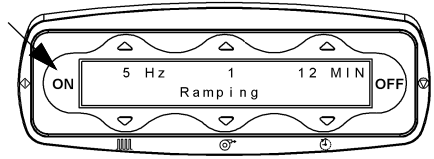

NOTE:

Therapy settings **can not** be changed during Ramping stage.

7. If it is necessary to pause the treatment during a session, do as follows:
 - a. Press the **OFF** button or the remote control once. The unit will stop the pulsations, but the settings will continue to show on the screen.

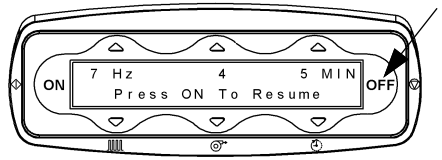

NOTE:

When the unit is paused, the inflatable garment will deflate.

- b. To resume treatment, press the **ON** button or the remote control again.



8. If it is necessary to end the treatment session before it is complete, press the **OFF** button twice.

NOTE:

Pressing the **OFF** button does not turn off the screen.

9. When the **OFF** button is pressed twice, the inflatable garment deflates and the "Incomplete X Min Remain" message shows on the screen. You must press the **ON** button to continue to the main screen.

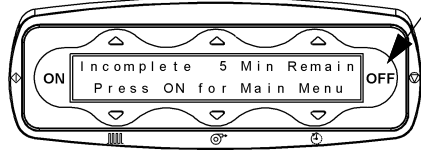

10. When the treatment session is complete:

- a. The "Session Complete" message shows.
- b. The pulsations stop.
- c. The inflatable garment deflates.



11. Unplug the system from its power source.
12. Remove the Air Hoses from the Air Hose Ports on the inflatable garment.
13. Remove the inflatable garment.

CHECK THE HOUR METER READING

The Hour Meter Reading will show on the screen when you first plug your device in. You can also access the Hour Meter Reading as follows:

- With the device plugged in, press the **On** button and then press the **Off** button. The Hour Meter Reading will show on the screen.

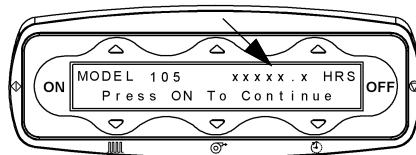

CHANGE THE LANGUAGE

1. Press the **ON** button.

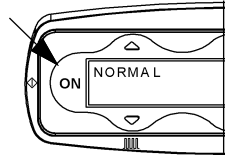

2. Press the **Up** arrow button above **NORMAL**. The Normal mode screen shows.

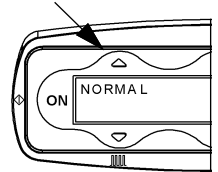

3. Press the two -outside **Down** arrow buttons at the same time for a minimum of 3 seconds (or until the screen changes).

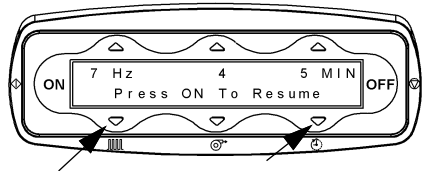

4. Press the middle **Down** arrow button until the desired language shows in all capital letters.

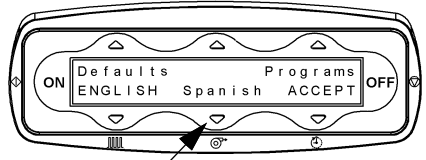

5. To accept the change, press the far right **Down** arrow button.

6. Once you have accepted the change, the system will automatically reboot and go back to the main screen in the applicable language.

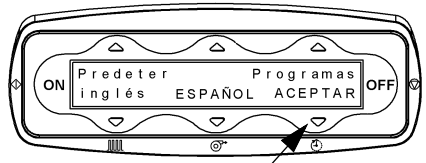

DISABLE THE PROGRAM MODES (PROGRAM AND RAMP MODES)

Disable the Program modes allows the unit to operate in Normal mode only, and removes access to custom modes by the user.

1. Press the **ON** button.

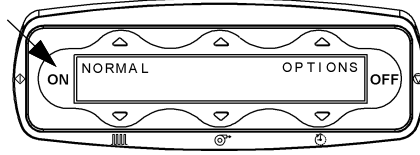

2. Press the left **Up** arrow button above **NORMAL**.
The Normal mode screen shows.

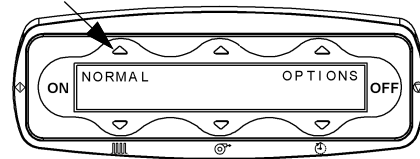

3. Press the two outside arrow buttons at the same time for a minimum of **3 seconds**, or until the screen changes.

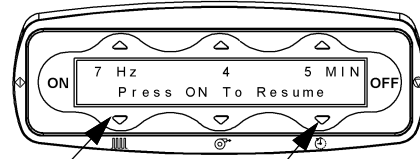

4. Press the right **Up** arrow button above **Programs**.

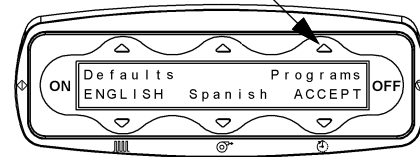

5. Press the right **Up** arrow button above **pgm disable** (it will turn to **PGM DISABLE**).

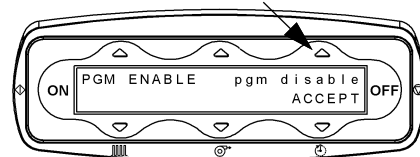

6. To accept the change, press the right **Down** arrow below **ACCEPT**.

7. To accept all changes and **exit** out of the menu, press the right **Down** arrow button below **ACCEPT**.

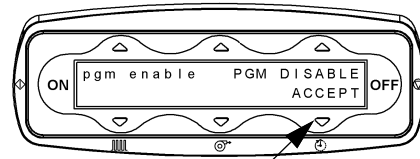

- Once you have accepted the change, the system will automatically reboot and go to the main screen of **NORMAL** mode. You will no longer be able to see the Program or Ramp mode programs.
- To switch back to Program mode, repeat the steps starting at step 2.

NOTE:

Press the **Up** arrow button above **pgm enable** at step 4 to enable the Program mode (it will change **pgm enable** to **PGM ENABLE**).

SET CUSTOM DEFAULT SETTINGS

Allows the user to set the default settings for the modes of operation. These settings will be the initial settings for all users.

- Press the **ON** button.

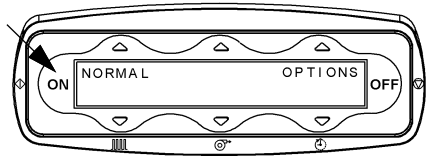

- Press the **Up** arrow button above **NORMAL**. The Normal mode screen shows.

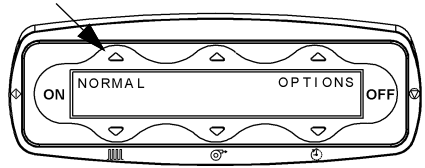

- Press the two outside **Down** arrows for a minimum of **3 seconds**, or until the screen changes.

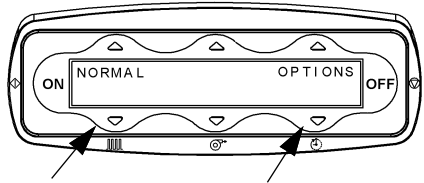

- Press the left **Up** arrow button above **Defaults**.
- Press the right **Up** arrow button above **default** (**Defaults** will change to **DEFAULTS**).

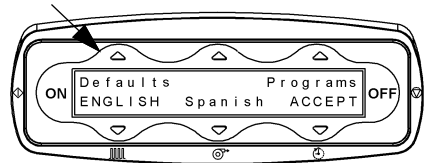

6. To accept the change, press the right **Down** arrow button below **ACCEPT**.

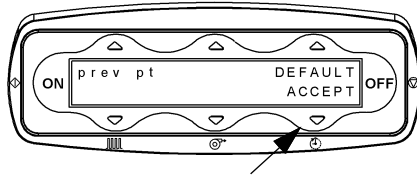

7. To adjust the **Maximum Run Time** use the **Up** and **Down** arrow buttons above and below **MIN** and then press the **ON** button.

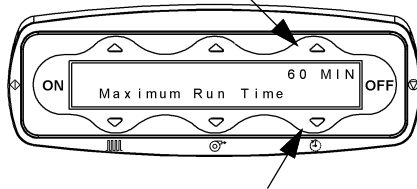

8. To set default Frequency, Pressure, and Time settings for Normal mode, adjust each by using the respective **Up** and **Down** arrow buttons and press the **ON** button.

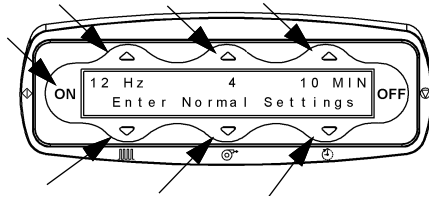

9. To adjust the default settings for **Program** mode, set each **Program Point** sequentially. Press the **ON** button to advance to the next Programming Point.

10. Adjust Frequency, Pressure, and Time for each **Program Point** (1 through 8) or change the time to zero, after the last desired Program Point, to make the previous point the last point.

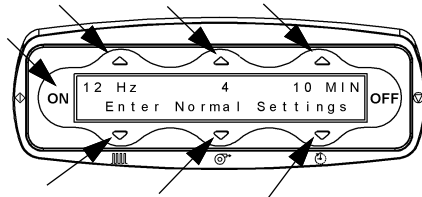

11. Press the **ON** button to advance to the next default setting.

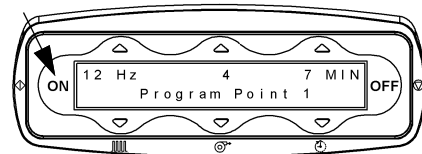

- Adjust the **Ramp Time Percent** for the **Default Ramp** mode using the right **Up** and **Down** arrow buttons, and press the **ON** button.

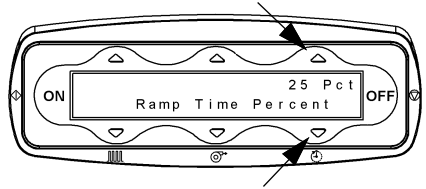

- Adjust the **Ramp Start Frequency, and Pressure** settings for default **Ramp** mode by using the left and middle **Up** and **Down** arrow buttons, and press the **ON** button.

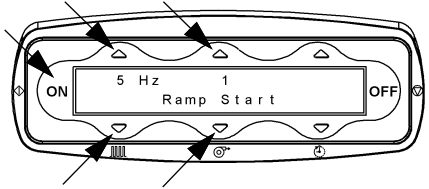

- Adjust the **Ramp End Mode Frequency, Pressure, and Time** settings using the **Up** and **Down** arrow buttons, and press the **ON** button.

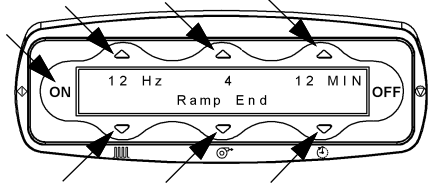

- To accept all of the changes, press the right **Down** arrow below **ACCEPT**.

- Once you have accepted the change, it will automatically reboot the system and go back to the main screen.

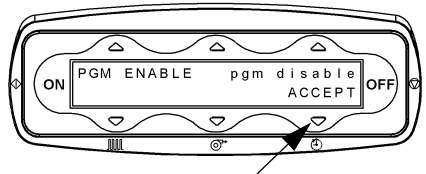

- To switch back to previous patient default mode, repeat the steps and select **prev pt** instead of **default**.

USE THE VEST AIRWAY CLEARANCE SYSTEM, SOFTWARE VERSION 1.22 OR 2.00 AND HIGHER

Make sure the unit is set up correctly. Once power is connected, the unit will show a blank screen for up to 15 seconds. Then it will show the model number and the total therapy hours for the unit. This screen shows for 10 seconds or until you press the **ON** button.

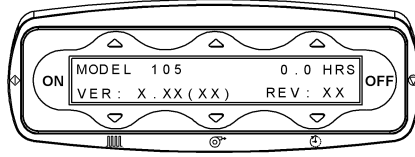

NOTE:

To show the total therapy hours, press the **OFF** button when the **Main** menu is shown.

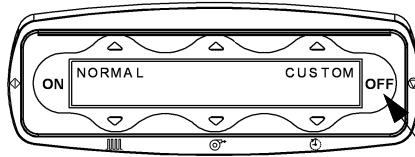

NORMAL MODE

The Normal mode is using one Frequency, Pressure, and Time settings for the entire therapy session.

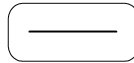

1. Press the **Up** arrow button above **NORMAL** for the standard operation mode. The screen will show the previously programmed Frequency, Pressure, and treatment Time settings (either factory settings or settings programmed by your clinical trainer based on your doctor's prescription).

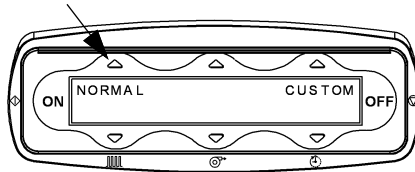

2. Confirm the settings on the screen. If the settings match the prescribed treatment, continue to step 3. Otherwise, adjust the settings to match the prescription.
 - a. To adjust the Frequency setting, press the left **Up** or **Down** arrow buttons until the prescribed treatment shows on the screen. The

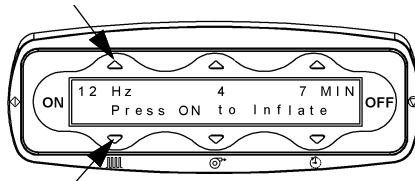

Frequency or Hertz (Hz) may be set between 5 and 20 cycles per second.

- b. To adjust the Pressure setting, press the middle **Up** or **Down** arrow buttons until the prescribed treatment Pressure shows on the screen.

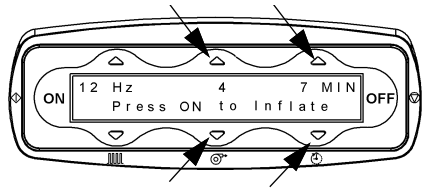

The Pressure may be set between 1 and 10.

- c. To adjust the treatment Time, press the right **Up** or **Down** arrow buttons until the prescribed treatment Time shows on the screen. The treatment Time may be set between 1 and 60 minutes.

NOTE:

It is not necessary to stop the treatment to adjust the settings.

3. Press the **ON** button. The inflatable garment will inflate.

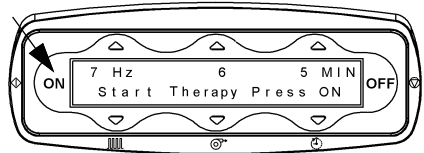

NOTE:

If the unit is left in this mode for 10 minutes, it will turn off.

4. Press the **ON** button again to begin the treatment. The set treatment Time shows as it counts down to zero.
5. If it is necessary to pause the treatment during a session, do as follows:

- a. Press the **OFF** button or the remote control once. The unit will stop the pulsations, but the settings will continue to show on the screen.

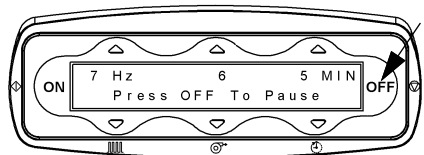

NOTE:

When the unit is paused, the inflatable garment will deflate.

- b. To resume treatment, press the **ON** button or the remote control again.

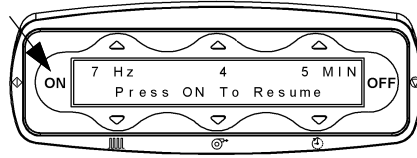

- 6. If it is necessary to end the treatment session before it is complete, press the **OFF** button twice.

NOTE:

Pressing the **OFF** button does not turn off the screen.

- 7. When the **OFF** button is pressed twice, the inflatable garment deflates and the "Incomplete X Min Remain" message shows on the screen. You must press the **ON** button to continue to the main screen.

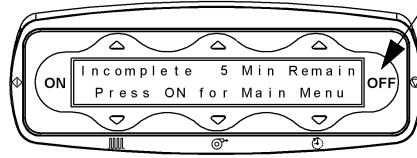

- 8. When the treatment session is complete:

- a. The "Session Complete" message shows.
- b. The pulsations stop.
- c. The inflatable garment deflates.



- 9. Unplug the system from its power source.
- 10. Remove the Air Hoses from the Air Hose Ports on the inflatable garment.
- 11. Remove the inflatable garment.

SET AND USE THE NEW PROGRAM MODE

The New Program mode allows the programming of Program A and Program B modes, each with up to eight (8) points with various settings within a single therapy session. It also allows the programming of the Cough Pause feature (reminder to cough).

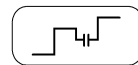

NOTE:

All the settings can be adjusted.

You can program up to 8 different Programming Points, each with its own combination of Frequency, Pressure, and treatment Time.



WARNING:

Warning—Consult your physician prior to changing prescribed settings. Failure to do so can cause personal injury.

1. Press the **ON** button.

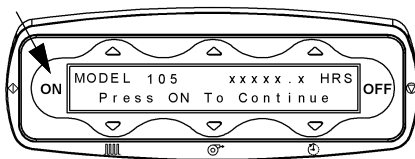

2. Press the **UP** arrow button above **CUSTOM**.

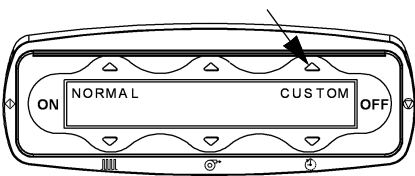

3. Do one of these:

- a. To program the Ramp mode, press the **Down** arrow under **RAMP NEW** and go to “Set and Use the New Ramp Mode” on page 55.

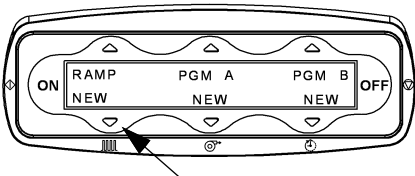

- b. To program Program A or Program B, press the **Down** arrow button below **PGM A NEW**, or **PGM B NEW** and go to step 4.

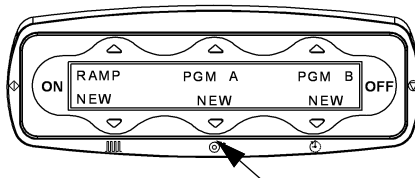

4. Press the **Up** or **Down** arrow for *Cough Pause Reminder* duration (time between cough pauses). A zero (0) time will turn off the Cough Pause feature.

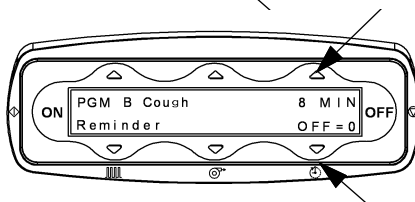

5. Press **On** to go to the next screen.

6. Press the **Up** or **Down** arrow to select the pause duration. This will set the duration the unit pauses for coughs.

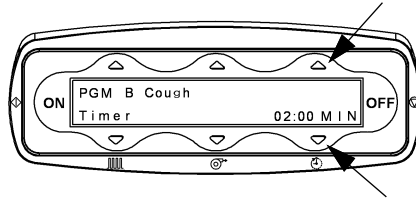

7. Press **On** to go to the next screen.

8. For Programming Point 1, if the settings match the prescribed treatment, continue to step 9.

Otherwise, adjust the settings to match the prescription by pressing the **Up** and **Down** arrow buttons associated with Frequency, Pressure, and treatment Time.

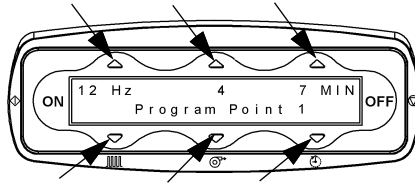

9. Once you have set Programming Point 1, proceed to Programming Point 2 by pressing the **ON** button (to move to a previous Programming Point, press the **OFF** button). Adjust the settings to match the prescription and repeat for all 8 Programming Points.

NOTE:

If the prescription does not call for all 8 Programming Points, **after** programming the last prescribed programming point, set the Time to 0 MIN for the following segment.

Once you change the Programming Point Time to 0 MIN and press the **ON** button, it will take you to the start of the program to begin therapy.

10. Press the **ON** button. The inflatable garment will inflate.
11. Press the **ON** button again to begin the treatment program. The set treatment Time shows as it counts down to zero for each Programming Point.
12. Therapy will automatically end after it has gone through each Programming Point.
13. If it is necessary to pause the treatment during a session, do as follows:

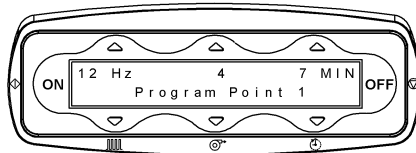

- a. Press the **OFF** button or the remote control once. The unit will stop the pulsations, but the settings will continue to show on the screen.

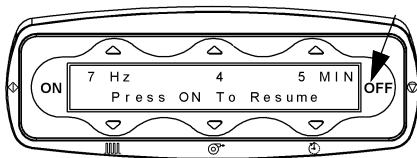

NOTE:

When the unit is paused, the inflatable garment will deflate.

- b. To resume treatment, press the **ON** button or the remote control again.
14. When the time for a cough pause is reached, these will happen:

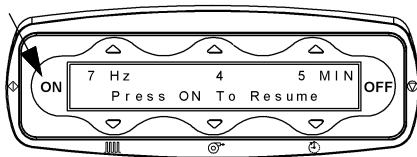

- a. The unit will pause.
- b. The display will change to show the pause duration timer.
- c. The garment will deflate.

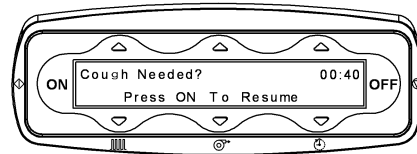

15. While the pause happens, the patient should cough as prescribed.
16. When the timer reaches zero, the garment will inflate, and therapy will resume.

NOTE:

If additional time is needed, press the **OFF** control to pause the unit.

To resume therapy before the cough pause timer expires, you can press **ON** or squeeze the remote control.

17. If it is necessary to end the treatment session before it is complete, press the **OFF** button twice.

NOTE:

Pressing the **OFF** button does not turn off the screen.

18. When the **OFF** button is pressed twice, the inflatable garment deflates and the "Incomplete X Min Remain" message shows on the screen. You must

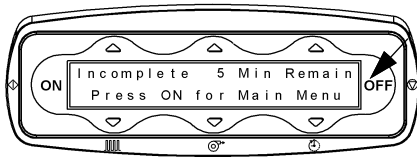

press the **ON** button to continue to the Program and Ramp main screen.

19. When the treatment session is complete:

- The "Session Complete" message shows.
- The pulsations stop.
- The inflatable garment deflates.



20. Unplug the system from its power source.

21. Remove the Air Hoses from the Air Hose Ports on the inflatable garment.

22. Remove the inflatable garment.

USE THE PROGRAM MODE

Runs a previously created **New** Program mode. See "Set and Use the New Program Mode" on page 48.

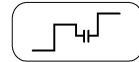

WARNING:

Warning—Consult your physician prior to changing prescribed settings. Failure to do so can result in personal injury.

1. Press the **ON** button.

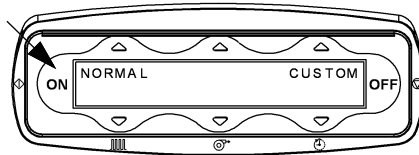

2. Press the **UP** arrow button above **CUSTOM**.

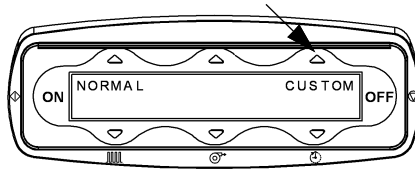

3. Press the **Up** arrow button above **PGM A** or **PGM B** to run the previously created program, or selected default program.

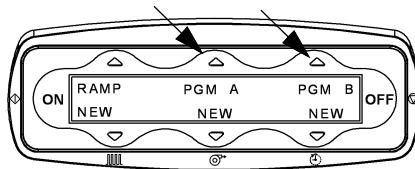

4. Press the **ON** button. The inflatable garment will inflate.
5. Press the **ON** button again to begin the treatment program. The set treatment Time shows as it counts down to zero for each Programming Point.

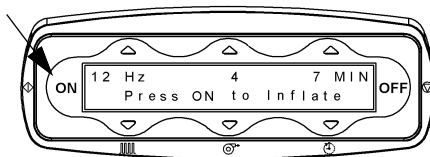

6. When the time for a cough pause is reached, these will happen:
 - a. The unit will pause.
 - b. The display will change to show the pause duration timer.
 - c. The garment will deflate.

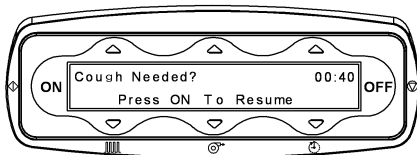

7. While the pause happens, the patient should cough as prescribed.
8. When the timer reaches zero, the garment will inflate, and therapy will resume.

NOTE:

If additional time is needed, press the **OFF** control to pause the unit.

9. To resume therapy before the cough pause timer expires, you can press **ON** or squeeze the remote control.
10. The therapy will automatically end after it has gone through each of the Programming Points.
11. If it is necessary to pause the treatment during a session, do as follows:
 - a. Press the **OFF** button or the remote control once. The unit will stop the pulsations, but the settings will continue to show on the screen.

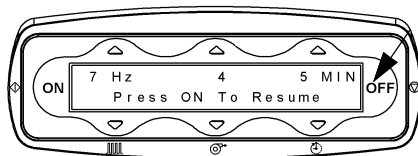
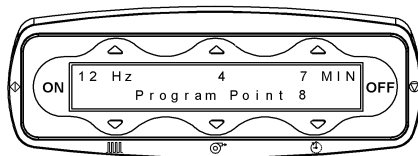

NOTE:

When the unit is paused, the inflatable garment will deflate.

- b. To resume treatment, press the **ON** button or the remote control again.

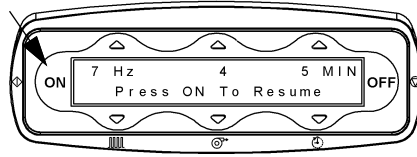

- 12. If it is necessary to end the treatment session before it is complete, press the **OFF** button twice.

NOTE:

Pressing the **OFF** button does not turn off the screen.

- 13. When the **OFF** button is pressed twice, the inflatable garment deflates and the "Incomplete X Min Remain" message shows on the screen. You must press the **ON** button to continue to the Program and Ramp main screen.

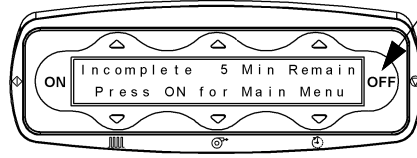

- 14. When the time for a cough pause is reached, these will happen:

- a. The unit will pause.
- b. The display will change to show the pause duration timer.
- c. The garment will deflate.



- 15. While the pause happens, the patient should cough as prescribed.
- 16. When the timer reaches zero, the garment will inflate, and therapy will resume.

NOTE:

If additional time is needed, press the **OFF** control to pause the unit.

To resume therapy before the cough pause timer expires, you can press **ON** or squeeze the remote control.

17. When the treatment session is complete:

- a. The "Session Complete" message shows.
- b. The pulsations stop.
- c. The inflatable garment deflates.
- d. Unplug the system from its power source.
- e. Remove the Air Hoses from the Air Hose Ports on the inflatable garment.
- f. Remove the inflatable garment.



SET AND USE THE NEW RAMP MODE

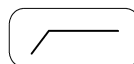

Creates a new Ramp Program to ease the patient from a lower setting to a higher setting during a limited period of the therapy session.



WARNING:

Warning—Consult your physician if not using the prescription as provided. Failure to do so can result in personal injury.

- 1. Press the **ON** button.

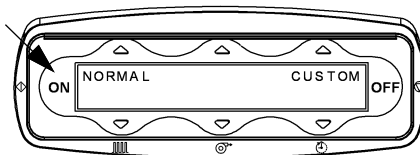

- 2. Press the **UP** arrow button above **CUSTOM**.

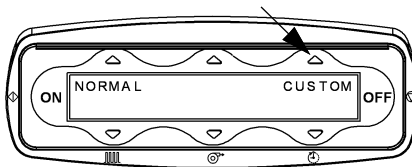

- 3. Press the **Down** arrow button below **New Ramp/New** to adjust the program settings.

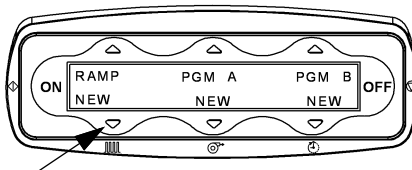

4. Look at the settings on the screen. **Ramp Time Percent** is the portion of the treatment Time required to increase from the initial settings (**Ramp Start**) to the final settings (**Ramp End**). To adjust the percent to the prescribed therapy, press the right **Up** or **Down** arrow buttons.

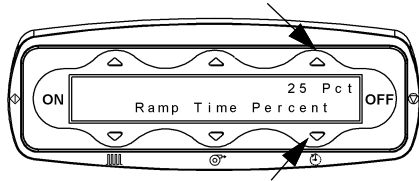

5. Press the **ON** button to advance to the next screen.
6. Review the settings for Frequency and Pressure for the initial setting, **Ramp Start**.

- a. To adjust the Frequency setting, press the left **Up** or **Down** arrow buttons until the prescribed treatment shows on the screen. The Frequency (or Hertz (Hz)) may be set between 5 and 20 cycles per second.

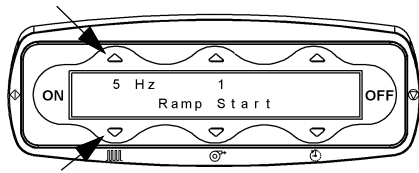

- b. To adjust the Pressure setting, press the middle **Up** or **Down** arrow buttons until the prescribed treatment Pressure shows on the screen. Pressure may be set between 1 and 10.

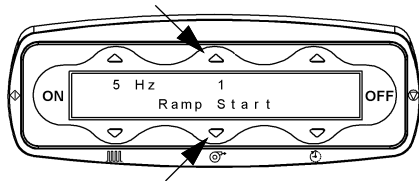

7. Press the **ON** button to advance to the next screen.
8. Review the settings on the screen. Frequency and Pressure for the final setting, **Ramp End**, are shown as treatment Time.
 - a. To adjust the Frequency setting, press the left **Up** or **Down** arrow buttons until the prescribed setting shows on the screen. Frequency or Hertz (Hz) may be set between the Ramp Start setting and 20 cycles per second.
 - b. To adjust the Pressure setting, press the middle **Up** or **Down** arrow buttons until the prescribed setting shows on the screen. Pressure may be set between the Ramp Start setting and 10.

- c. To adjust the treatment Time, press the right **Up** or **Down** arrow buttons until the prescribed treatment Time shows on the screen. The treatment Time may be set between 1 and 60 minutes.

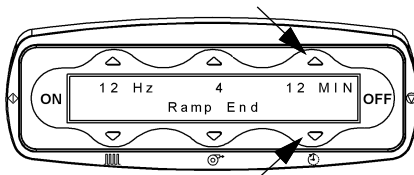

9. Press the **ON** button to advance to the next screen. This screen shows the summary of the ramp program you have just created.

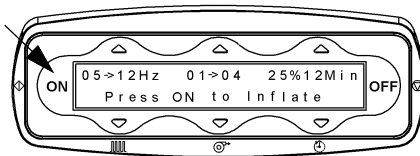

10. Press the **ON** button. The inflatable garment will inflate.

11. Press the **ON** button again to begin the therapy. The screen will show the word "Ramping" during the ramp portion of the program. The total treatment Time shows as it counts down to zero.

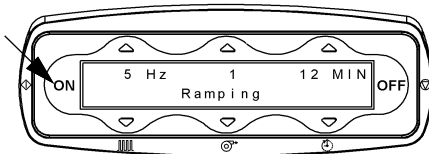

NOTE:

Therapy settings **can not** be changed during Ramping stage.

12. If it is necessary to pause the treatment during a session, do as follows:
- Press the **OFF** button or the remote control once. The unit will stop the pulsations, but the settings will continue to show on the screen.

NOTE:

When the unit is paused, the inflatable garment will deflate.

- To resume treatment, press the **ON** button or the remote control again.
13. If it is necessary to end the treatment session before it is complete, press the **OFF** button twice.

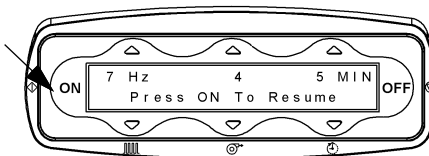

NOTE:

Pressing the **OFF** button does not turn off the screen.

14. When the **OFF** button is pressed twice, the inflatable garment deflates and the “Incomplete X Min Remain” message shows on the screen. You must press **ON** to continue to the main screen.

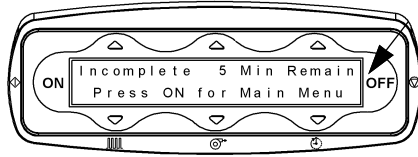

15. When the treatment session is complete:

- a. The “Session Complete” message shows.
- b. The pulsations stop.
- c. The inflatable garment deflates.

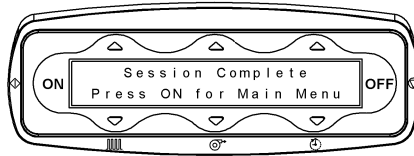

- 16. Unplug the system from its power source.
- 17. Remove the Air Hoses from the Air Hose Ports on the inflatable garment.
- 18. Remove the inflatable garment.

USE THE RAMP MODE

Runs a previously created Ramp Program. See “Set and Use the New Ramp Mode” on page 55.

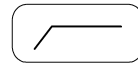

WARNING:

Warning—Consult your physician if not using the prescription as provided. Failure to do so can result in personal injury.

1. Press the **ON** button.

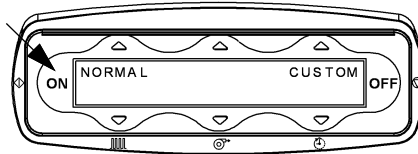

2. Press the **UP** arrow button above **Custom**.

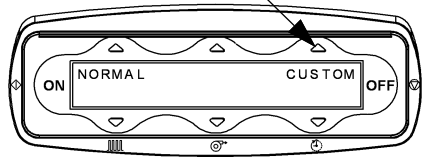

3. Press the **Up** arrow button above **RAMP** to run the previously created ramp program.

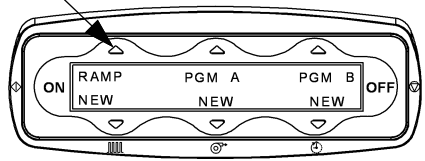

4. The programmed points will be shown. Press the **ON** button to advance to the next screen.

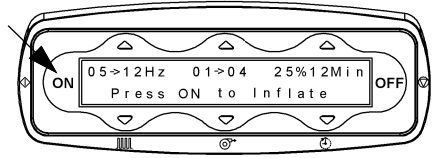

5. Press the **ON** button. The inflatable garment will inflate.

6. Press the **ON** button again to begin the program. The screen will show the word "Ramping" during the ramp portion of the program. The total treatment Time shows as it counts down to zero.

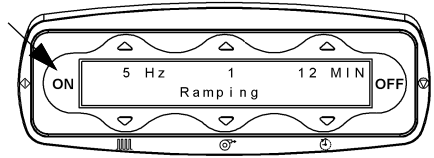

NOTE:

Therapy settings **cannot** be changed during Ramping stage.

7. If it is necessary to pause the treatment during a session, do as follows:
 - a. Press the **OFF** button or the remote control once. The unit will stop the pulsations, but the settings will continue to show on the screen.

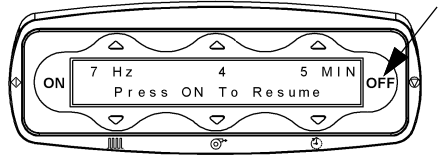

NOTE:

When the unit is paused, the inflatable garment will deflate.

- b. To resume treatment, press the **ON** button or the remote control again.

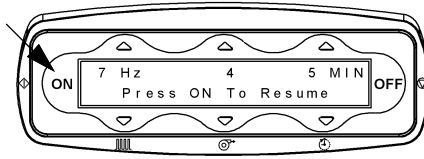

- 8. If it is necessary to end the treatment session before it is complete, press the **OFF** button twice.

NOTE:

Pressing the **OFF** button does not turn off the screen.

- 9. When the **OFF** button is pressed twice, the inflatable garment deflates and the "Incomplete X Min Remain" message shows on the screen. You must press the **ON** button to continue to the main screen.

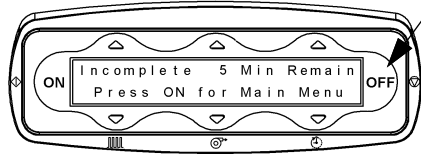

- 10. When the treatment session is complete:

- a. The "Session Complete" message shows.
- b. The pulsations stop.
- c. The inflatable garment deflates.

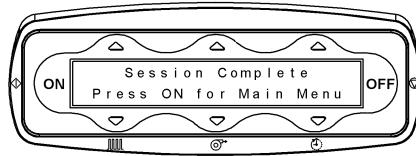

- 11. Unplug the system from its power source.
- 12. Remove the Air Hoses from the Air Hose Ports on the inflatable garment.
- 13. Remove the inflatable garment.

CHECK THE HOUR METER READING

The Hour Meter Reading will show on the screen when you first plug your device in. You can also access the Hour Meter Reading as follows:

- With the device plugged in, press the **ON** button and then press the **OFF** button. The Hour Meter Reading will show on the screen.

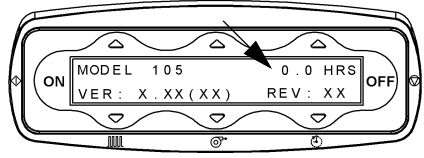

CHANGE THE LANGUAGE

1. Press the **ON** button.

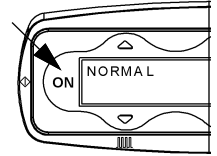

2. Press the **Up** arrow button above **NORMAL**. The Normal mode screen shows.

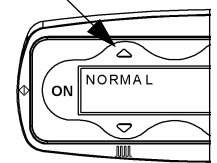

3. Press the two outside **Down** arrow buttons at the same time for a minimum of 3 seconds (or until the screen changes).

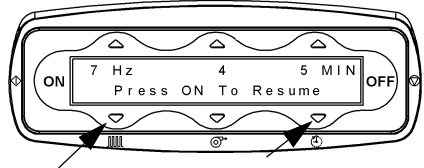

4. Press the middle **Down** arrow button until the desired language shows in all capital letters.

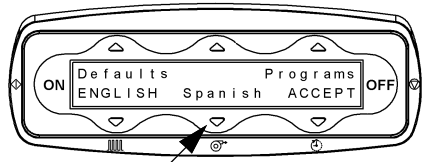

- To accept the change, press the far right **Down** arrow button.
- Once you have accepted the change, the system will automatically reboot and go back to the main screen in the applicable language.

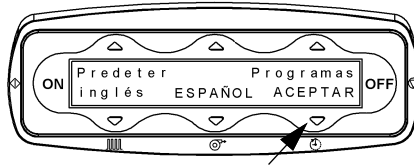

DISABLE THE PROGRAM MODES (PROGRAM AND RAMP MODES)

Disable the Program modes allows the unit to operate in Normal mode only, and removes access to custom modes by the user.

- Press the **ON** button.

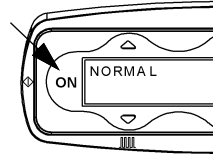

- Press the left **Up** arrow button above **NORMAL**. The Normal mode screen shows.

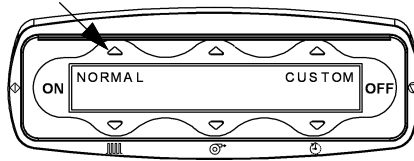

- Press the two outside **Down** arrow buttons at the same time for a minimum of **3 seconds**, or until the screen changes.

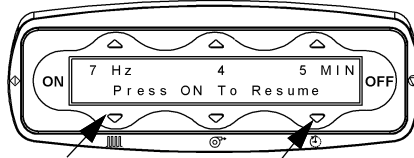

- Press the right **Up** arrow button above **Programs**.

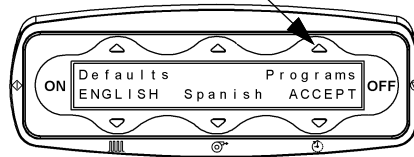

5. Press the right **Up** arrow button above **pgm disable** (it will turn to **PGM DISABLE**).

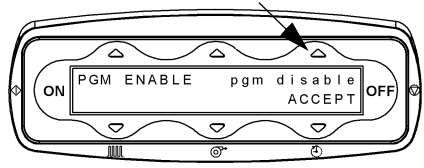

6. To accept the change, press the right **Down** arrow below **ACCEPT**.

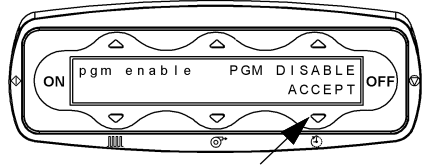

7. To accept all changes and **exit** out of the menu, press the right **Down** arrow button below **ACCEPT**.
8. Once you have accepted the change, the system will automatically reboot and go to the main screen of **NORMAL** mode. You will no longer be able to see the Program or Ramp mode programs.
9. To switch back to Program mode, repeat the steps starting at step 3.

NOTE:

Press the **Up** arrow button above **pgm enable** at step 4 to enable the Program mode (it will change **pgm enable** to **PGM ENABLE**).

SET CUSTOM DEFAULT SETTINGS

Allows the user to set the default settings for the modes of operation. These settings will be the initial settings for all users.

1. Press the **ON** button.

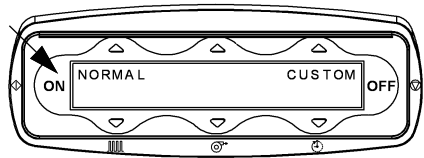

2. Press the **Up** arrow button above **NORMAL**. The Normal mode screen shows.

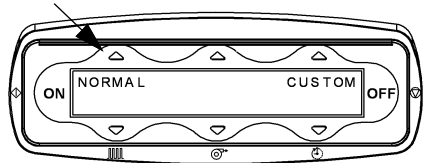

3. Press the two outside **Down** arrows for a minimum of **3 seconds**, or until the screen changes.

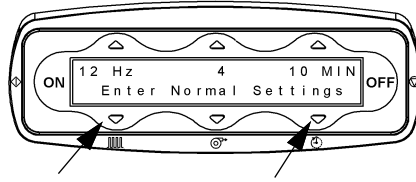

4. Press the left **Up** arrow button above **Defaults**.

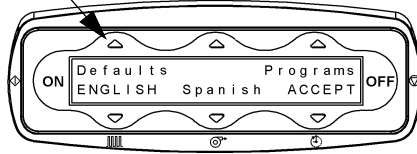

5. Press the right **Up** arrow button above **default** (**Defaults** will change to **DEFAULTS**).
6. To accept the change, press the right **Down** arrow button below **ACCEPT**.

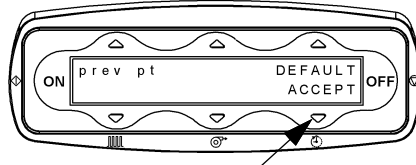

7. To adjust the **Maximum Run Time** use the **Up** and **Down** arrow buttons above and below **MIN** and then press the **ON** button.

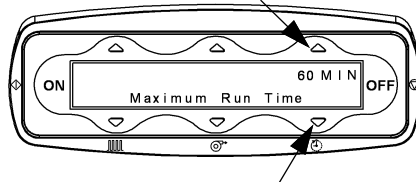

8. Do one of these:

- a. To change the default Normal settings, press the **Up** arrow above **NORMAL**, and go to step 9.
- b. To change the default settings of Program A press the **Up** arrow above **PGM A**, or press the **Down** arrow below **PGM B**, and go to step 10.
- c. To change the default Ramp settings, press the **Down** arrow below **RAMP**, and go to step 18.
- d. Press **ON** to accept changes or to advance to the next screen and go to step 21.

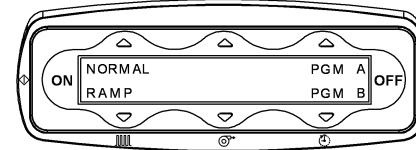

- To set default Frequency, Pressure, and Time settings for **Normal** mode, adjust each by using the respective **Up** and **Down** arrow buttons, press the **ON** button and return to step 8.

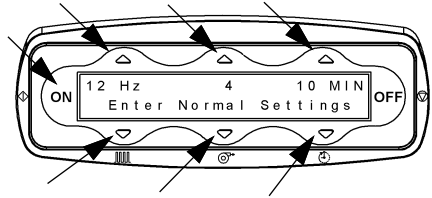

- Press the **Up** or **Down** arrow for **Cough Pause Reminder** duration (time between cough pauses). A zero (0) time will turn off the Cough Pause feature.

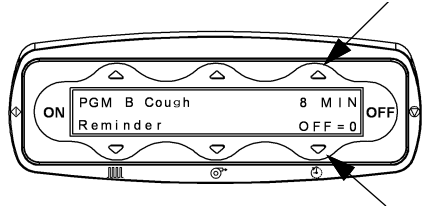

- Press **On** to go to the next screen.
- Press the **Up** or **Down** arrow to select the pause duration. This will set the duration the unit pauses for coughs.

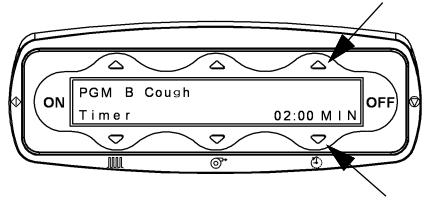

- Press **On** to go to the next screen.
- Press the **Down** arrow under **Yes** or **No** for the Auto Start feature.

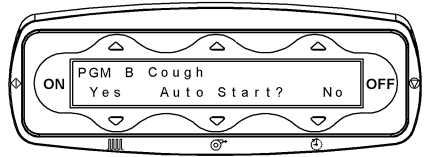

NOTE:

Auto Start resumes therapy after cough pause duration expires.

- Press **On** to go to the next screen.
- Adjust Frequency, Pressure, and Time for each **Program Point** (1 through 8) or change the time to zero, after the last desired Program Point, to make the previous point the last point.

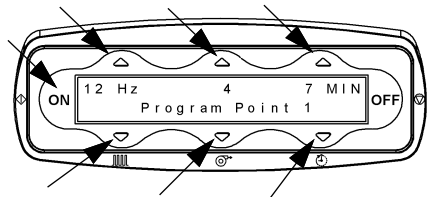

17. Press the **ON** button to advance to the next default setting, and return to step 8.

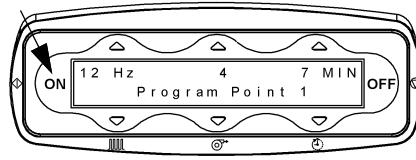

18. Adjust the **Ramp Time Percent** for the **Default Ramp** mode using the right **Up** and **Down** arrow buttons, and press the **ON** button.

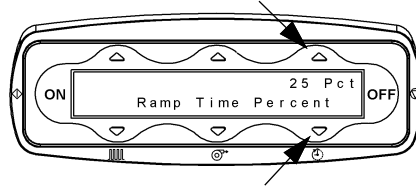

19. Adjust the **Ramp Start Frequency, and Pressure** settings for default **Ramp** mode by using the left and middle **Up** and **Down** arrow buttons, and press the **ON** button.

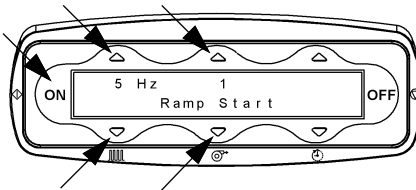

20. Adjust the **Ramp End** settings for default **Ramp** mode **Frequency, Pressure, and Time** settings using the **Up** and **Down** arrow buttons, and press the **ON** button and return to step 8.

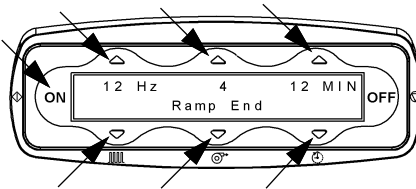

21. To accept all of the changes, press the right **Down** arrow below **ACCEPT**.

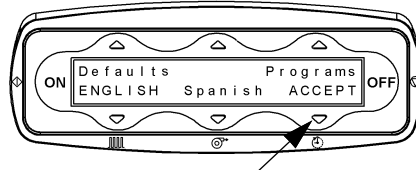

22. Once you have accepted the change, it will automatically reboot the system and go back to the main screen.

23. To switch back to previous patient default mode, repeat steps 3 through 5 and select **prev pt** instead of **default**.

CLEANING



WARNING:

When you clean and disinfect the device, follow these safety instructions; otherwise, personal injury or equipment damage could occur:

- **Warning**—The potential for electrical shock exists with electrical equipment. Failure to follow facility protocols may cause death or serious injury.
- **Warning**—Unplug the unit from its power source.
- **Warning**—Do not expose the unit to excessive moisture.
- **Warning**—Inspect the Air Pulse Generator and Garments before each use. In addition, after each cleaning cycle, visually inspect each component for any wear, tear, or deformity. If you have any concern about a component, do **not** use it, and replace that component before the next therapy session.
- **Warning**—Do not use harsh cleansers, solvents, or detergents.
- **Warning**—Use cleaning and disinfectant products in accordance with the manufacturer's instructions.

We recommend that you clean the unit with detergent and warm water. Do not use excessive liquid or harsh cleansers.



CAUTION:

Caution—Do not use harsh cleansers, solvents, or detergents. Equipment damage could occur.

The Vest Airway Clearance System has been tested for compatibility with these cleaning solutions recommended for routine cleaning and disinfection:

Cleaner/Disinfectant	Active Ingredients
Cavicide	Diisobutylphenoxyethoxyethyl dimethyl benzyl ammonium chloride—0.28% Isopropanol—17.20%
Virex II 256	Didecyl dimethyl ammonium chloride—8.704% Alkyl dimethyl benzyl ammonium chloride—8.19%
Wex-Cide	Ortho-Phenylphenol—0.026% Ortho-Benzyl-para-Chlorophenol—0.023%

NOTE:

Use the disinfectant as specified in the disinfectant manufacturer's instructions.

GENERAL CLEANING—AIR PULSE GENERATOR AND CLASSIC GARMENT LINE

NOTE:

The non-washable garments are referred to as the Classic Line, and the washable garments are referred to as the **C3** Garment Line.

NOTE:

The garments are not made with natural rubber latex, and are for single-patient use on individual patients over multiple treatment sessions.

We recommend that you wipe clean the Air Pulse Generator and inflatable garment with detergent and warm water. Do not use excessive liquid or harsh cleansers, and do **not** put **The Vest** Airway Clearance System in water or any solution.

Make sure to thoroughly clean the inside and outside of these:

- Ends of the Air Hoses
- Connection Ports on the reusable garment
- Air Hose Connector Port outlets on the Air Pulse Generator

When there is visible soilage, we recommend that you use a standard household, mild antibacterial soap or solution to clean the unit.

Dilute the cleaning agent as specified on the manufacturer's label.

DO NOT STEAM CLEAN—AIR PULSE GENERATOR AND CLASSIC GARMENTS

Do not use any steam cleaning device on the unit or garments. Excessive moisture can damage mechanisms in this unit or garments.

CLEANING HARD TO CLEAN SPOTS—AIR PULSE GENERATOR AND CLASSIC GARMENTS

To remove difficult spots or stains, we recommend that you use standard household cleansers and a soft bristle brush. To loosen heavy, dried-on soil, you may first need to saturate the spot.

Do **not** put **The Vest** Airway Clearance System in water or any solution.

C3 GARMENT LINE CLEANING

Only the outer piece of the **C3** Garment Line can be machine washed. The bladder is cleaned in the same manner as the Classic garment above.

NOTE:

The garments and bladders are not made with natural rubber latex, and are for single-patient use on individual patients over multiple treatment sessions.

Remove the bladder assembly as follows:

- Open up the buckles or hook and loop connections and lay the garment flat on a table.
- Open the zipper or flap at the bottom of the garment.
- If there are snaps that secure the bladder to the outer garment, unfasten the snaps.
- Remove the two hose connections from the outer garment.
- Remove the bladder from the outer garment.

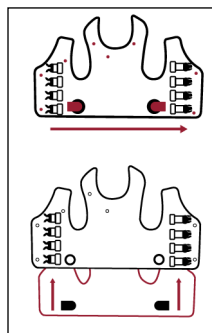

Machine wash the **outer piece only** as follows:

- Fasten all buckles, zippers and hook and loop connections.

NOTE:

The 16" garment has hook and loop connections only.

- Machine wash, or hand wash, in cold cycle only (86°F (30°C) maximum). Non-chlorine bleach may be used as necessary.
- Hang dry or tumble dry on lowest temperature (120°F (49°C) maximum).
- Cool iron (230°F (110°C) maximum) as necessary. Do **not** iron the design. Do not machine wash or dry the bladder.

NOTE:

Use a piece of clear tape to remove any lint or fluff caught on the hook and loop connections.

MAINTENANCE



WARNING:

Warning—Only authorized personnel should service **The Vest** Airway Clearance System. Servicing by unauthorized personnel could cause personal injury or equipment damage.

The Vest Airway Clearance System requires minimal routine maintenance. Periodic cleaning is required (see “Cleaning” on page 67).

If service is necessary, use this contact information:

- In the USA, call Hillrom at 800-426-4224, or go to respiratorycare.hillrom.com.
- Outside of the USA, contact your distributor or local Hillrom representative, or go to baxter.com.

DISPOSAL INSTRUCTIONS

Users must adhere to all federal, state, regional, and/or local laws and regulations as it pertains to the safe disposal of medical devices and accessories. If in doubt, the user of the device shall first contact Hillrom Technical Support for guidance on safe disposal protocols.

- To ensure safe handling and disposal of this product, follow all relevant warnings, cleaning and disinfection instructions in this manual.
- Always ensure that the product is unplugged or powered off before disposal.
- Always check and comply with all local, national regulations and facility protocols for disposal information.



If applicable, batteries should be recycled. Never dispose of batteries which contain substances that can be dangerous for the environment and health.



Other components, such as electronic components, plastics and metals, are recyclable in many local jurisdictions. Hillrom recommends recycling all components that can be recycled locally.

Components which cannot be recycled can be disposed of via standard waste disposal procedures.

EXPECTED LIFE

The expected service life for the air pulse generator is two years from date of purchase.

The expected service life of the hoses and the remote control is thirty days from date of purchase.

The expected service life of the reusable vest garment is one year from date of purchase.

Hillrom will repair or replace a defective unit as part of a warranty package specified at the time of purchase of the device, which may extend beyond the expected service life specified above based on servicing and warranty costs.

DEVICE ERRORS

If an error occurs on **The Vest** Airway Clearance System, Model 105, a device error may show on the display. If a number does show, make a note of the number and supply it to Hillrom when you call for assistance.

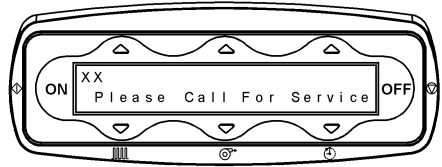

SERVICE CALLS

If service is necessary on **The Vest** Airway Clearance System, Model 105, use this contact information:

- In the USA, call Hillrom at 800-426-4224, or go to respiratorycare.hillrom.com.
- Outside of the USA, contact your distributor or local Hillrom representative, or go to baxter.com.

When you contact Hillrom, be prepared to give the serial number from the product identification label. The product identification label is on the rear panel of the Air Pulse Generator.

TROUBLESHOOTING



WARNING:

Warning—Only authorized personnel should service **The Vest** Airway Clearance System, Model 105. Servicing by unauthorized personnel could cause personal injury or equipment damage. Do not modify this device without the authorization of the manufacturer. To do so could cause personal injury or equipment damage.

Minimal routine maintenance and periodic cleaning are necessary for **The Vest** Airway Clearance System, Model 105.

Facilities should do these tests and examinations annually:

- Unplug the Air Pulse Generator from its power source.
- Examine the overall condition of the unit for damage or missing parts.
- Examine the power cord and connector for cuts, scrapes, or other damage.
- Do the electrical safety tests in accordance with facility protocols.
- Clean the unit (see “Cleaning” on page 67).

Connect the Air Pulse Generator to an inflatable garment and to an appropriate power source. Make sure the unit is operational, and that all the functions operate correctly.

AIR PULSE GENERATOR DOES NOT POWER ON

1. Make sure the power cord is securely plugged into the electrical inlet on the rear panel of the Air Pulse Generator. If necessary, unplug the power cord from the Air Pulse Generator, and then reconnect.
2. Make sure the power cord is securely plugged into an appropriate power source.
3. If the problem still exists, contact Hillrom.

NO AIR PULSES INTO THE INFLATABLE GARMENT

1. If using the remote control, make sure it is securely connected to the Remote Control Port on the front panel of the Air Pulse Generator.
2. Make sure the Air Hoses are connected to the inflatable garment and Air Pulse Generator.
3. Make sure the **ON** button has been pressed.
4. If the problem still exists, contact Hillrom.

SCREEN SHOWS “PLEASE CALL FOR SERVICE” MESSAGE

The system has experienced an unexpected event. Do as follows:

1. Unplug the power cord from the Air Pulse Generator, and then plug it in again.
2. If the problem is not corrected, contact Hillrom.

AN AIR HOSE COMES OUT OF THE AIR PULSE GENERATOR OR INFLATABLE GARMENT DURING OPERATION

1. Fully disconnect the Air Hoses from the Air Pulse Generator and the inflatable garment.
2. Clean the inside and outside of these:
 - Ends of the Air Hose
 - Connection Ports on the inflatable garment
 - Air Hose Connector Ports outlets on the Air Pulse Generator
3. Connect the Air Hoses to the Air Pulse Generator and the inflatable garment (see “Setting Up the Unit” on page 19).
4. If the problem is not corrected, contact Hillrom.

SCREEN SHOWS “RESTARTING”

1. The system has experienced an unexpected event and is restarting.
2. If the problem is not corrected, contact Hillrom.

THE INFLATABLE GARMENT NO LONGER FITS

1. Adjust the inflatable garment to accommodate normal growth:
 - To fit a Chest Vest, refer to “Fitting the Classic Chest Vest” on page 22.
 - To fit a Full Vest, refer to “Fitting the C3 Washable Garment and the Classic Full Vest” on page 24.
 - To fit a Wrap Vest, refer to “Fitting the Classic Wrap Vest” on page 26.
2. If the problem still exists, contact Hillrom.

STORAGE AND HANDLING

To store or transport **The Vest** Airway Clearance System, do as follows:

1. Put the Air Pulse Generator in the roller bag.
2. Put the Air Hoses in either of the end compartments.
3. Put the inflatable garment in the other end compartment along with the remote control and power cord.
4. Close the roller bag to secure the unit inside.



SHIPPING THE UNIT



CAUTION:

Caution—If shipping is required, the original packing material provides the best protection for **The Vest** Airway Clearance System. Retain the original packaging material. Failure to do so could cause equipment damage.

If shipping is required, ship the unit in its original packing material.

SPECIFICATIONS

Feature	Dimension
Air Pulse Generator weight	17 lb (8 kg)
Air Pulse Generator height	9.5" (24.1 cm)
Air Pulse Generator width	13" (33 cm)
Air Pulse Generator depth	9.5" (24.1 cm)
Inflatable garment material—Chest	Polyvinyl chloride (PVC)-coated polyester with polyurethane-coated nylon
Inflatable garment material—Full	Polyurethane-coated nylon
Inflatable garment material—Wrap	Polyester with PVC, polyurethane, or PVC/polyurethane blend coating
Inflatable garment material—C3 Garments	Outer piece—Polyester Bladder—Urethane and urethane coated nylon twill
Electrical requirements	100 V AC to 230 V AC, 50 Hz to 60 Hz 3.4 A @ 100 VAC 2.0 A @ 230 VAC
Fuse requirement	4 A, 5 x 20 mm (fast blow, high breaking fuse)

Environmental Conditions for Transport and Storage

Condition	Range
Temperature	-13°F to 158°F (-25°C to 70°C)
Relative humidity	93% non-condensing

Environmental Conditions for Use

Condition	Range
Temperature	41°F to 95°F (5°C to 35°C) ambient temperature
Relative humidity range	15% to 93% non-condensing
Atmospheric pressure	700 hPa to 1060 hPa

Classification and Standards

Classification	Standards
Technical and Quality Assurance—Devices with serial numbers 63-XXXXX, 64-XXXXX, and 65-XXXXX	ANSI/AAMI ES60601-1 ANSI/AAMI HA60601-1-11 CAN/CSA-C22.2 No. 60601-1 CAN/CSA-C22.2 No. 60601-1-11 IEC/EN 60601-1 IEC/EN 60601-1-6 IEC/EN 60601-1-11 IEC/EN 62366-1 EN ISO 13485
Technical and Quality Assurance—Devices with serial numbers 61-XXXXX and 62-XXXXX	UL/EN/IEC 60601-1 CAN/CSA C22.2 No. 601.1 ISO 13485
Equipment Classification	Percussor, powered electric Class II
Degree of Protection Against Electric Shock	BF with type F applied part
Classification According to Directive 93/42/EEC	Ila
Degree of Protection Against Ingress of Water	IP21
Not for use with flammable anesthetics.	

The Vest Airway Clearance System, Model 105 is a continuous operation device classified with Underwriters Laboratories Inc. (UL) in the United States and licensed with Health Canada.

ELECTROMAGNETIC COMPATIBILITY GUIDANCE

The Vest Airway Clearance System, Model 105 is suitable for use in all establishments, including domestic establishments and those directly connected to the public low-voltage power supply network that supplies buildings used for domestic purposes.



WARNING:

To help prevent injury and/or equipment damage, obey these **warnings**:

- **Warning**—Portable RF communications equipment (including peripherals such as antenna cables and external antennas) should be used no closer than 30 cm (12 inches) to any part of **The Vest** Airway Clearance System, Model 105, including cables specified by the manufacturer. Otherwise, degradation of the performance of this equipment could result.
- **Warning**—**The Vest** Airway Clearance System, Model 105 should not be used adjacent to or stacked with other equipment. If adjacent or stacked use is necessary, **The Vest** Airway Clearance System, Model 105 should be observed to verify normal operation. If operation is not normal, **The Vest** Airway Clearance System, Model 105 or any other equipment should be moved.
- **Warning**—Use of accessories, transducers, and cables, other than those specified or provided by the manufacturer of this equipment, could result in increased electromagnetic emissions or decreased electromagnetic immunity of this equipment and result in improper operation.

Guidance and Manufacturer’s Declaration— Electromagnetic Emissions

<p>The Vest Airway Clearance System, Model 105 is intended for use in the electromagnetic environment specified below. The customer or user of the Model 105 should make sure it is used in such an environment.</p>		
Emissions Test	Compliance	Electromagnetic Environment—Guidance
RF emissions CISPR 11	Group 1	The Vest Airway Clearance System, Model 105 uses RF energy only for its internal function. Therefore, its RF emissions are very low and are not likely to cause any interference in nearby electronic equipment.
RF emissions CISPR 11	Class B	The Vest Airway Clearance System, Model 105 is suitable for use in all establishments, including domestic establishments and those directly connected to the public low-voltage power supply network that supplies buildings used for domestic purposes.
Harmonic emissions IEC 61000-3-2	Class A	
Voltage fluctuations/ flicker emissions IEC 61000-3-3	Complies	

Guidance and Manufacturer's Declaration— Electromagnetic Immunity

The Vest Airway Clearance System, Model 105 is intended for use in the electromagnetic environment specified below. The customer or user of the Model 105 should make sure it is used in such an environment.			
Immunity Test	IEC 60601 Test Level	Compliance Level	Electromagnetic Environment—Guidance
Electrostatic discharge (ESD) IEC 61000-4-2	± 8 kV contact ± 15 kV air	± 8 kV contact ± 15 kV air	Floors should be wood, concrete, or ceramic tile. If floors are covered with synthetic material, the relative humidity should be at least 30%.
Electrical fast transient/burst IEC 61000-4-4	± 2 kV for power supply lines ± 1 kV for input/output lines	± 2 kV for power supply lines Not applicable	Mains power quality should be that of a typical commercial or hospital environment.
Surge IEC 61000-4-5	± 1 kV line(s) to line(s) ± 2 kV line(s) to earth	± 1 kV line(s) to line(s) Not applicable	Mains power quality should be that of a typical commercial or hospital environment.
Voltage dips, short interruptions and voltage variations on power supply input lines IEC 61000-4-11	0% U_T for 0.5 cycle at: 0°, 45°, 90°, 135°, 180°, 225°, 270°, and 315°. 0% U_T for 1 cycle 70% U_T for 25/30 cycles, single phase at 0°. 0% U_T for 250/300 cycles	0% U_T for 0.5 cycle at: 0°, 45°, 90°, 135°, 180°, 225°, 270°, and 315°. 0% U_T for 1 cycle 70% U_T for 25/30 cycles, single phase at 0°. 0% U_T for 250/300 cycles	Mains power quality should be that of a typical commercial or hospital environment. If it is necessary for the user to have continued operation of the Model 105 during power mains interruptions, it is recommended that the Model 105 be powered from an uninterruptible power supply.
Power frequency (50/60 Hz) magnetic field IEC 61000-4-8	30 A/m	30 A/m	Power frequency magnetic fields should be at levels characteristic of a typical location in a typical commercial or hospital environment.
NOTE: U_T is the AC mains voltage prior to application of the test level.			

Guidance and Manufacturer’s Declaration— Electromagnetic Immunity

<p>The Vest Airway Clearance System, Model 105 is intended for use in the electromagnetic environment specified below. The customer or user of the Model 105 should make sure it is used in such an environment.</p>			
Immunity Test	IEC 60601 Test Level	Compliance Level	Electromagnetic Environment—Guidance
<p>Conducted RF IEC 61000-4-6</p> <p>Radiated RF IEC 61000-4-3</p>	<p>3 Vrms 150 kHz to 80 MHz</p> <p>10 V/m 80 MHz to 2,7 GHz</p>	<p>3 V</p> <p>10 V/m</p>	<p>Portable and mobile RF communications equipment should be used no closer to any part of the Model 105, including cables, than the recommended separation distance calculated from the equation applicable to the frequency of the transmitter.</p> <p>Recommended separation distance</p> <p>150 kHz to 80 MHz $d = \left[\frac{3.5}{3} \right] \sqrt{P}$</p> <p>80 MHz to 800 MHz $d = \left[\frac{3.5}{10} \right] \sqrt{P}$</p> <p>800 MHz to 2,7 GHz $d = \left[\frac{7}{10} \right] \sqrt{P}$</p> <p>where P is the maximum output power rating of the transmitter in watts (W) according to the transmitter manufacturer and d is the recommended separation distance in meters (m).</p> <p>Field strengths from fixed RF transmitters, as found by an electromagnetic site survey^a, should be less than the compliance level in each frequency range^b.</p> <p>Interference may occur in the vicinity of equipment marked with this symbol:</p> <div style="text-align: right;">  </div>
<p>NOTES:</p> <ul style="list-style-type: none"> • At 80 MHz and 800 MHz, the higher frequency range applies. • These guidelines may not apply in all situations. Electromagnetic propagation is affected by absorption and reflection from structures, objects, and people. • Electromagnetic immunity was examined under normal operation at the time of testing. Electromagnetic immunity was verified at settings of 4 for intensity and 12 Hz for frequency. <p>a. Field strengths from fixed transmitters, such as base stations for radio (cellular/cordless) telephones and land mobile radios, amateur radio, AM and FM radio broadcast, and TV broadcast can not be predicted theoretically with accuracy. To assess the electromagnetic environment due to fixed RF transmitters, the electromagnetic site used should be considered. If the measured field strength in the location in which the Model 105 is used is more than the applicable RF compliance level above, the Model 105 should be monitored to make sure it operates correctly. If it operates incorrectly, additional measures may be necessary, such as a change in the Model 105’s position or location.</p> <p>b. Over the frequency range 150 kHz to 80 MHz, field strengths should be less than 3 V/m.</p>			

Recommended Separation Distances Between Portable and Mobile RF Communications Equipment and The Vest Airway Clearance System, Model 105

<p>The Vest Airway Clearance System, Model 105 is intended for use in an electromagnetic environment in which radiated RF disturbances are controlled. The customer or user of The Vest Airway Clearance System, Model 105 can help prevent electromagnetic interference by maintaining the minimum distance between portable and mobile RF communications equipment (transmitters) and The Vest Airway Clearance System, Model 105 as recommended below, according to the maximum output power of the communications equipment.</p>			
Rated Maximum Output Power of the Transmitter Watts (W)	Separation Distance According to the Frequency of the Transmitter Meters (m)		
	150 kHz to 80 MHz $d = \left[\frac{3.5}{3} \right] \sqrt{P}$	80 MHz to 800 MHz $d = \left[\frac{3.5}{10} \right] \sqrt{P}$	800 MHz to 2,7 GHz $d = \left[\frac{7}{10} \right] \sqrt{P}$
0,01 W	0,12 m	0,04 m	0,07 m
0,1 W	0,37 m	0,11 m	0,22 m
1 W	1,17 m	0,35 m	0,70 m
10 W	3,69 m	1,11 m	2,21 m
100 W	11,67 m	3,50 m	7,00 m
<p>For transmitters rated at a maximum output power not listed above, the recommended separation distance d in meters (m) can be estimated using the equation applicable to the frequency of the transmitter, where P is the maximum output power rating of the transmitter in watts (W) according to the transmitter manufacturer.</p> <p>NOTES:</p> <ul style="list-style-type: none"> • At 80 MHz to 800 MHz, the separation distance for the higher frequency range applies. • These guidelines may not apply in all situations. Electromagnetic propagation is affected by absorption and reflection from structures, objects, and people. 			

Guidance and Manufacturer's Declaration— Electromagnetic Immunity to Wireless Communications Equipment

The **Vest** Airway Clearance System, Model 105 is intended for use in the electromagnetic environment specified below. The customer or user of the Model 105 should make sure it is used in such an environment.

Sides Tested	Frequency (MHz)	Test Severity Level	Test Distance (m)
Front, back, left, right	385	27V/m, 50% PM 18Hz	0.3
Front, back, left, right	450	28V/m, FM \pm 5kHz, 1kHz	0.3
Front, back, left, right	710	9V/m, 50% PM 217Hz	0.3
Front, back, left, right	745	9V/m, 50% PM 217Hz	0.3
Front, back, left, right	780	9V/m, 50% PM 217Hz	0.3
Front, back, left, right	810	28V/m, 50% PM 18Hz	0.3
Front, back, left, right	870	28V/m, 50% PM 18Hz	0.3
Front, back, left, right	930	28V/m, 50% PM 18Hz	0.3
Front, back, left, right	1720	28V/m, 50% PM 217Hz	0.3
Front, back, left, right	1845	28V/m, 50% PM 217Hz	0.3
Front, back, left, right	1970	28V/m, 50% PM 217Hz	0.3
Front, back, left, right	2450	28V/m, 50% PM 217Hz	0.3
Front, back, left, right	5240	9V/m, 50% PM 217Hz	0.3
Front, back, left, right	5500	9V/m, 50% PM 217Hz	0.3
Front, back, left, right	5785	9V/m, 50% PM 217Hz	0.3

FREQUENTLY ASKED QUESTIONS

- How does **The Vest** Airway Clearance System effectively treat areas of my lungs?
 - The system is designed to oscillate the chest wall to create airflow by applying percussion to the lung area to treat the lobes of the lung.
- How long should my Airway Clearance Therapy treatment session last?
 - Common prescriptions specify a treatment session Time to be between 10 and 30 minutes. Prescribed treatment session times may be different. Refer to the physician's order.
- How often should my treatment sessions be given?
 - The frequency of treatment sessions depends on your underlying disease, age, and state of health. Your physician will prescribe a schedule for your individual needs.
- Is chest physiotherapy still necessary?
 - Refer to the physician's order.
- Is postural drainage still necessary?
 - Refer to the physician's order.
- What will happen if I miss a treatment session?
 - One missed treatment session of the system may or may not affect your health. However, the key to help maintain your health is consistent, effective therapy. Try to follow the physician's care plan as closely as possible. Consult your physician if a treatment session is missed.
- Is there a best time to do a therapy with **The Vest** Airway Clearance System?
 - Establish a schedule that works for you and your family, and lets you do the therapy consistently.
- Do all patients receive the same benefits from **The Vest** Airway Clearance System?
 - The overall benefit depends on many factors, which include the underlying disease, patient's age, and present state of health.

